



PEARL

**Allocation in the Life Cycle Assessment (LCA) of Flax Fibres for the Reinforcement of Composites**

Summerscales, John; Dissanayake, Nilmini p. j.

**Published in:**

ADVANCES IN NATURAL FIBRE COMPOSITES: RAW MATERIALS, PROCESSING AND ANALYSIS

**DOI:**

[10.1007/978-3-319-64641-1\\_19](https://doi.org/10.1007/978-3-319-64641-1_19)

**Publication date:**

2017

**Document version:**

Publisher's PDF, also known as Version of record

**Link:**

[Link to publication in PEARL](#)

**Citation for published version (APA):**

Summerscales, J., & Dissanayake, N. P. J. (2017). Allocation in the Life Cycle Assessment (LCA) of Flax Fibres for the Reinforcement of Composites. In R. Figueiro, & S. Rana (Eds.), *ADVANCES IN NATURAL FIBRE COMPOSITES: RAW MATERIALS, PROCESSING AND ANALYSIS* (Vol. 2017-August, pp. 223-235). Article Chapter 19 Springer International Publishing AG. [https://doi.org/10.1007/978-3-319-64641-1\\_19](https://doi.org/10.1007/978-3-319-64641-1_19)

All content in PEARL is protected by copyright law. Author manuscripts are made available in accordance with publisher policies. Wherever possible please cite the published version using the details provided on the item record or document. In the absence of an open licence (e.g. Creative Commons), permissions for further reuse of content should be sought from the publisher or author.

2017-08-20

# Allocation in LCA of flax fibres for the reinforcement of composites

Summerscales, J

<http://hdl.handle.net/10026.1/14203>

---

10.1007/978-3-319-64641-1\_19

ADVANCES IN NATURAL FIBRE COMPOSITES: RAW MATERIALS, PROCESSING AND ANALYSIS

Springer

---

*All content in PEARL is protected by copyright law. Author manuscripts are made available in accordance with publisher policies. Please cite only the published version using the details provided on the item record or document. In the absence of an open licence (e.g. Creative Commons), permissions for further reuse of content should be sought from the publisher or author.*

# ALLOCATION IN THE LIFE CYCLE ASSESSMENT (LCA) OF FLAX FIBRES FOR THE REINFORCEMENT OF COMPOSITES

John Summerscales and Nilmini P J Dissanayake

School of Engineering, Plymouth University, Drake Circus, Plymouth PL4 8AA, United Kingdom  
[jsummerscales@plymouth.ac.uk](mailto:jsummerscales@plymouth.ac.uk)      <https://www.plymouth.ac.uk/acmc>

**Keywords:** Allocation; Composites; Flax fibre; Flax seed;  
Life cycle assessment; LCA; Reinforcement.

## ABSTRACT

The ISO 14040 series of standards describe the principles and framework for the conduct of life cycle assessment (LCA). The system defines four phases: (i) definition of the goal and scope of the LCA, (ii) the life cycle inventory analysis (LCI), (iii) the life cycle impact assessment (LCIA), and (iv) the life cycle interpretation. The standards do not describe the LCA technique in detail, nor do they specify methodologies for the individual phases of the LCA. Dependent of the goal and scope, there can be very different outcomes from the analysis. This paper considers how the outcomes might change for the specific case of flax fibres for the reinforcement of composites. The study compares allocation of environmental burdens to two different primary products: (i) flax seed as a nutritional supplement with fibre generated from the waste stream, or (ii) flax fibre as the primary product.

## 1 INTRODUCTION

There is a considerable activity in the academic study and commercial exploitation of natural fibres as the reinforcement for polymer matrix composites [1-6]. These NFRP materials are often referred to as “sustainable composites” although very few LCA are available to confirm or refute that description.

Ekvall and Finnveden [7] undertook a critical review of the adequacy and feasibility of methods recommended for allocation by the (then) current international standard on life cycle inventory analysis with a focus on multi-functional systems. They demonstrated that different approaches to the allocation problems result in different types of information. They recommended, “that all of the environmental burdens of the multifunction process be allocated to the product investigated”. LCA results appear to be largely dependent on the chosen allocation methods used. ISO14040/ISO14044 [8, 9] also recommend avoiding allocation whenever possible either through subdivision of certain processes or by expanding the system limits to include associated additional functions.

Dissanayake et al undertook an investigation into energy use in the production [10], and Life Cycle Impact Assessment (LCIA) [11], of UK flax fibre for the reinforcement of composites. The Functional Unit (FU) was one tonne of fibre as either sliver (aligned mat) or yarn (twisted filament) based on an assumption of equivalent specific modulus. The respective moduli and densities for flax or glass were taken as 42 GPa or 72 GPa and 1500 or 2500 kg/m<sup>3</sup>. The analysis adopted the Ekvall and Finnveden allocation recommendation of all burdens assigned to the primary product. The harvested flax can produce seed, long fibre (used for composite reinforcement in this study), short fibre (used for paper-making or animal bedding) and dust (briquetted for solid bio-fuel).

Le Duigou et al. [12] conducted an environmental impact analysis on French flax fibres using a different set of underlying assumptions. They concluded, “without the allocation procedure the results from the two studies (France vs UK) would be similar”. The key differences were:

- UK plants desiccated at mid-point flowering but French plants allowed to set seed,
- UK yield only 6000 kg/ha, but French yield 7500 kg/ha at harvest,
- UK study excluded photosynthesis and CO<sub>2</sub> sequestration,
- Higher level of nuclear power in the French energy mix, and
- UK allocated all burdens to fibre, French allocated on mass of product and co-products.

## 2 ANALYSIS

Table 1 shows the relative allocation of burdens for single products, then for multifunctional systems based on economic value allocation and on mass allocation. The chosen goal and scope can clearly influence the reported environmental credentials of the respective products. Mass allocation has lower variability whereas value allocation is susceptible to price fluctuations for the respective co-products with the time.

Scenario			Allocation of burdens			
Single product	Mass/tonne yarn	Value/kg	Seed	Long	Short	Dust
Flax seed (FS)	500 (3%)	£3	<b>100%</b>	~	~	~
Flax long fibre (FLF)	1000 (6%)	£0.90	~	<b>100%</b>	~	~
Flax short fibre (FSF)	5000 (30%)	£0.10				
Shive/dust	10000 (61%)	£0.10				
Multiple products		Allocation				
FS and FLF	Value allocation	<b>62.5%</b>	37.5%	~	~	
FS/FLF/FSF	Value allocation	<b>51.7%</b>	31.0%	17.2%	~	
FS/FLF/FSF and	Value allocation	<b>38.5%</b>	23.1%	12.8%	25.6%	
FS and FLF	Mass allocation	33.3%	<b>66.7%</b>	~	~	
FS/FLF/FSF	Mass allocation	7.7%	15.4%	<b>76.9%</b>	~	
FS/FLF/FSF and	Mass allocation	3.0%	6.1%	30.3%	<b>60.6%</b>	

Table 1: Yields, allocation and assigned relative burdens for flax products

The environmental burdens identified by the International Organization for Standardization (ISO/TR 14047:2003) [13] have been translated to environmental impact classification factors (EICF) by Azapagic et al [14, 15]:

- Global Warming Potential (GWP)
- Acidification Potential (AP)
- Eutrophication Potential (EP)
- Human Toxicity Potential (HTP)
- Aquatic Toxicity Potential (ATP)
- Ozone Depletion Potential (ODP)
- Photochemical Oxidants Creation Potential (POCP)
- Non-Renewable/Abiotic Resource Depletion (NRADP).

The environmental burdens generated by flax fibres for the reinforcement of composites can be minimised when the plant is grown **primarily** for **seed** as a nutritional supplement, the flax is a co-product, and the Ekvall and Finnveden [7] allocation recommendation is followed. Under those conditions, the high embodied energy in the agro-chemicals and the environmental burdens arising from the agricultural operations are allocated 100% to the seed. At the other extreme, when the plant is desiccated at mid-point flowering, there is no seed produced, so all environmental burdens must be allocated to the fibre.

The analysis in Table 1 assumes that seed-plus-fibre is a single co-product system with environmental burdens from all operations shared by the co-products. In the case where flax seed (health food supplement) is the primary product, the processing for fibre should not be included in the environmental burdens allocated to the seed. The flax fibre can be considered as a burden-free raw material resource as those burdens are already taken by the seed. However, burdens will arise from the post-harvest processing. Appendices 1-7 present the data compiled by Dissanayake [10, 11] and then consider the proportionate burdens to be allocated to the fibre arising as a waste from seed production. Table 2 summarises the burdens arising from the fibre processing and their respective percentages.

<b>Environmental burden</b>	<b>S1 sliver</b>	<b>S2 sliver</b>	<b>S3 sliver</b>	<b>S1 yarn</b>	<b>S2 yarn</b>	<b>S3 yarn</b>
Global Warming Potential (GWP: kg CO <sub>2</sub> )	1973 (16%)	2566 (14%)	14217 (63%)	6110 (37%)	6708 (29%)	18328 (68%)
Acidification Potential (AP: in kg of SO <sub>2</sub> )	ppm (0%)	ppm (0%)	0 (0%)	ppm (0%)	ppm (0%)	0 (0%)
Eutrophication Potential (EP: kg of PO <sub>4</sub> <sup>3</sup> )	ppm (0%)	ppm (0%)	0 (0%)	ppm (0%)	ppm (0%)	0 (0%)
Human Toxicity Potential (HTP: kg)	ppm (0%)	ppm (0%)	0 (0%)	ppm (0%)	ppm (0%)	0 (0%)
Aquatic Toxicity Potential (ATP: in m <sup>3</sup> x 10 <sup>12</sup> )	0 (0%)	0 (0%)	0 (0%)	0 (0%)	0 (0%)	0 (0%)
Ozone Depletion Potential (ODP: ng of CFC-11)	850 (10%)	6224 (26%)	0 (0%)	860 (10%)	6300 (26%)	0 (0%)
Photochemical Oxidants Creation Potential (POCP: kg x 10 <sup>-6</sup> of ethylene)	1.2 (11%)	8.7 (27%)	0 (0%)	1.2 (11%)	8.7 (27%)	0 (0%)
Non-Renewable/Abiotic Resource Depletion Potential (NRADP: parts per 10 <sup>15</sup> )	Not available					

Table 2: Proportionate environmental burdens arising from fibre processing when flax fibres are produced from the waste stream of flax seed production

Figures 1-7 present “radar plots” for the EICF in Table 2. Appendix 9 presents LCIA results per tonne of glass fibre production derived from EcoInvent v2.0 [16].

### 3 DISCUSSION

When flax fibre is harvested at mid-point flowering (no seed produced), the global warming potentials (GWP) are similar to those for glass fibre [10, 11] for best agricultural practice (no-till then water-retting (S1: Scenario 1). However, the fibre is less “sustainable” for conservation-tillage then stand/dew-retting (S2: Scenario 2) and especially for conventional tillage then bio-retting (S3: Scenario 3). This study considers flax fibre derived as a waste product from the production of flax seed following the Ekvall and Finnveden [7] recommendation of all relevant environmental burdens assigned to the primary product. Figures 1-6 clearly show that assigning the environmental burdens to seed as the primary product enhances the “sustainable” credentials of flax fibre for the reinforcement of composites.

The dataset used for the analysis here is incomplete. There was no comparison data available for ATP for glass fibres and NRADP values were not available. The other six EICF were directly compared with glass fibres considering either flax fibres as the primary product or flax seeds as the primary product. Lignification of the flax plant during maturation of the seed after mid-point flowering will potentially increase the burdens from retting and decortication. Further, the fibre quality and properties may be compromised when sourced from older plants.

The dataset in the Appendices considers only oil, gas and coal under non-renewable/abiotic resource depletion. There is increasing concern that soil is becoming a more critical finite resource [17]. After the compilation of the dataset underlying the analysis in this paper, BS8905:2011 [18] on the sustainable use of materials identified land-use an additional factor to be analysed.

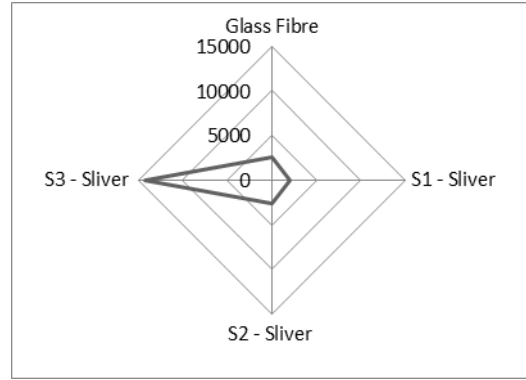
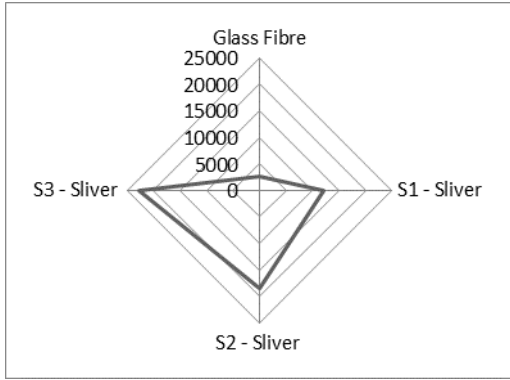

Figure 1: Radar plot of the Global Warming Potential (GWP) for flax fibre sliver referenced to glass fibres: (a) flax fibres as primary product (left), (b) flax seed as primary product (right).

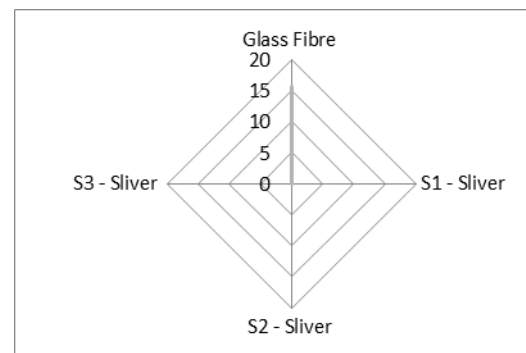

Figure 2: Radar plot of the Acidification Potential (AP) for flax fibre sliver referenced to glass fibres: (a) flax fibres as primary product (left), (b) flax seed as primary product (right).

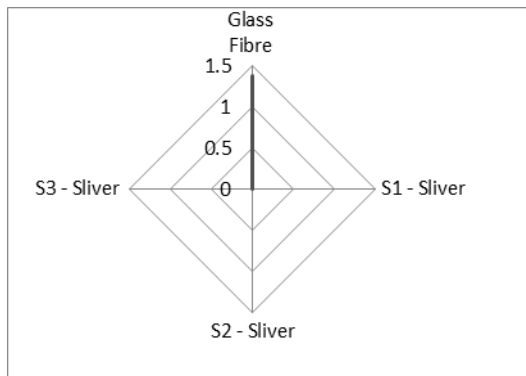
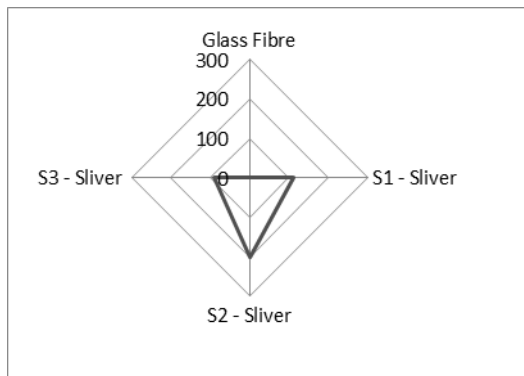

Figure 3: Radar plot of the Eutrophication Potential (EP) for flax fibre sliver referenced to glass fibres: (a) flax fibres as primary product (left), (b) flax seed as primary product (right).

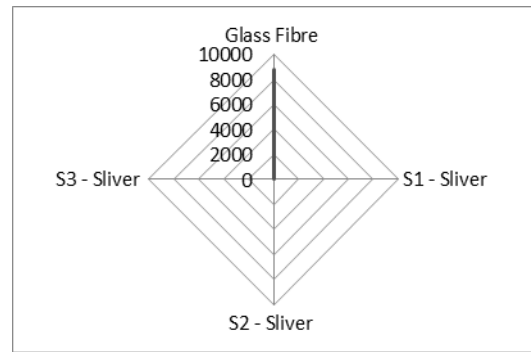
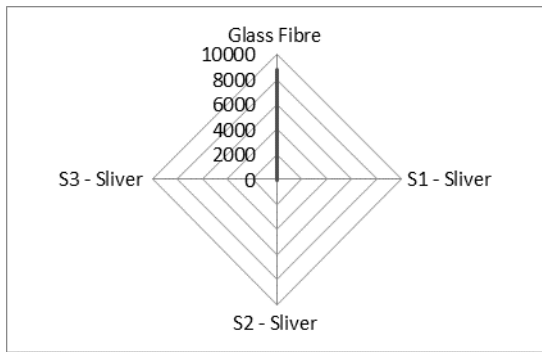

Figure 4: Radar plot of the Human Toxicity Potential (HTP) for flax fibre sliver referenced to glass fibres: (a) flax fibres as primary product (left), (b) flax seed as primary product (right).

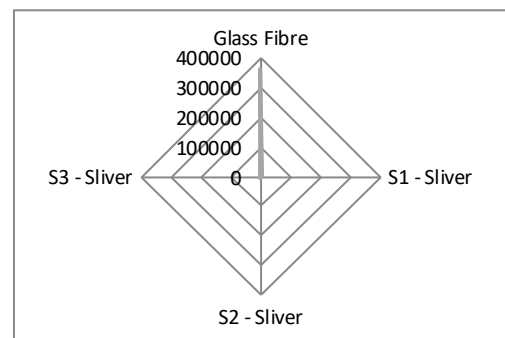
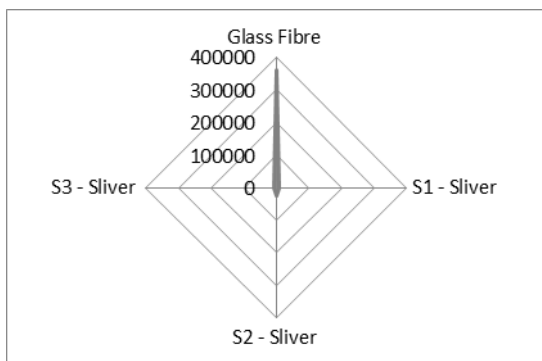

Figure 5: Radar plot of the Ozone Depletion Potential (ODP) for flax fibre sliver referenced to glass fibres: (a) flax fibres as primary product (left), (b) flax seed as primary product (right).

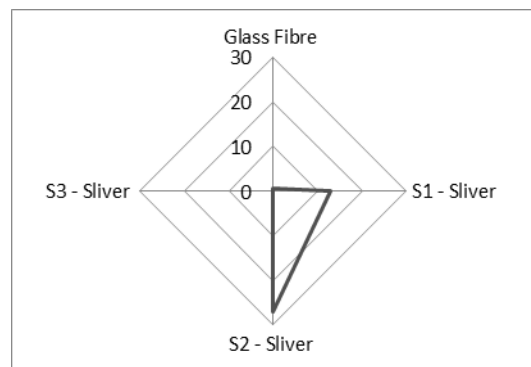
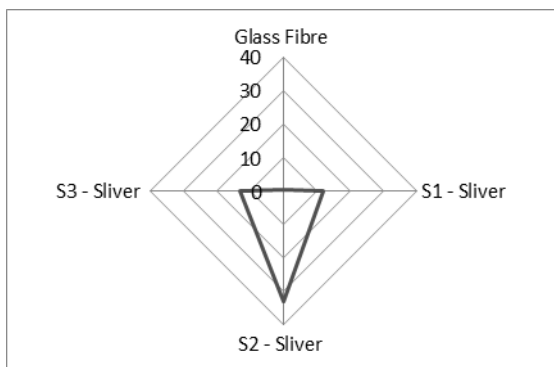

Figure 6: Radar plot of the Photochemical Oxidants Creation Potential (POCP) for flax fibre sliver referenced to glass fibres: (a) flax fibres as primary product (left), (b) flax seed as primary product (right).

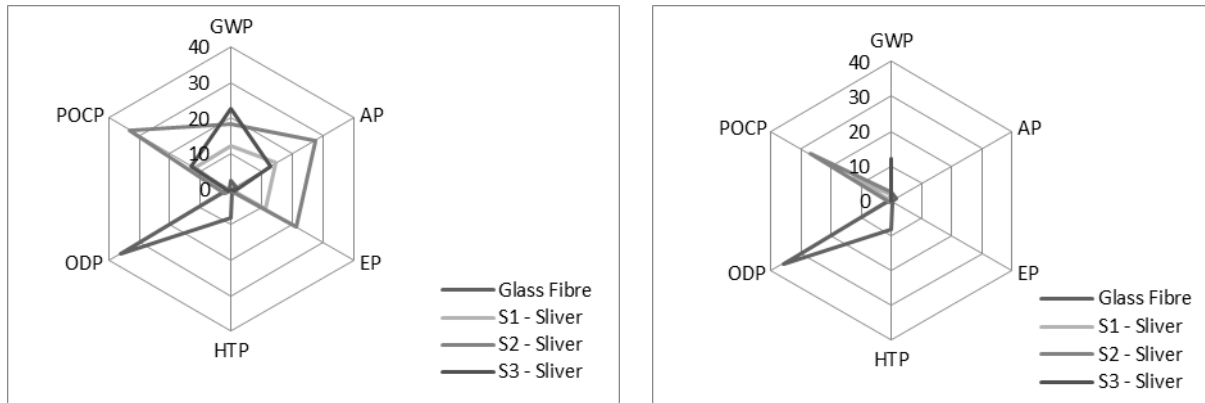

Figure 7: Radar plot of the comparison of GWP, AP, EP, HTP, ODP and POCP for flax fibre sliver referenced to glass fibres: (a) flax fibres as primary product (left), (b) flax seed as primary product (right).

GWP for glass fibre production is lower than for flax sliver production when the flax fibres are considered to be the primary product and the impacts are allocated to the fibre. The values are comparable (slightly lower than glass fibre production, ~2635 to 1973 kg of CO<sub>2</sub>) for S1 sliver production when the flax seeds are considered to be the primary product. The impacts arising from agrochemical intensive flax cultivation were allocated completely to the seed, not to the fibre. Nitrogen fertiliser used in crop production is the highest contributor in AP hence no values are recorded in all three scenarios for AP when the burdens are allocated for seed. The major contributors for EP are N and P fertiliser, and zero values are recorded in all three scenarios where flax seed is considered to be the primary product. The values recorded in this study for HTP and ODP for flax sliver production in both cases (flax fibre as primary product and flax seed as primary product) are negligible compared to the values obtained for glass fibre. The POCP values are dependent of the diesel consumption in crop production and retting, therefore higher values are recorded in flax sliver production than the glass fibre production.

The radar plots clearly show how the EICFs change with allocation procedures. The three scenarios considering flax seed as the primary products have improved sustainability credentials for flax fibre. S1 sliver production (no-till then water-retting) has the minimum environmental impact (GWP is lower than for glass fibre and POCP is higher than for glass fibre production). The fibre extraction processes might need improving (*e.g.* retting) as the mature stems are only available after seed extraction when seed is considered as the primary product. Glass fibre production clearly has ODP and HTP impacts, whereas flax fibre production has no impact on those categories. The flax sliver production has EP, AP and POCP impacts, whereas glass fibre has no impact on those categories. GWP seems to be the only impact category that could be compared with nominal values in this analysis.

The analysis need to be improved for other two impact categories (ATP and NRADP) for the comparison to be complete. The other impact categories that can be quantified and omitted from this analysis (*eg.* land use, CO<sub>2</sub> sequestration etc) also need to be addressed to fully understand the environmental implications in flax fibre and glass fibre production. The differences in fibre processing methods also need to be investigated when the mature stems (after seeding) are used to produce sliver.

A UN Human Rights Council [19] report states, “Reliance on hazardous pesticides is a short-term solution that undermines the rights to adequate food and health for present and future generations”, and “Pesticides contaminate and degrade soil to varying degrees”. In consequence, the analysis in this paper may underestimate the burdens arising from HTP, ATP and NRADP. The eight EICF considered align with ISO/TR 14047:2003 [13], but the two toxicity burdens may not adequately address “loss of biodiversity”, especially in the context of pollinators.



#### **4 CONCLUSIONS**

Variation is observed in the LCA study with the two different allocation methods in place. The analysis considering flax seed as the primary product has resulted in improved environmental credentials for the flax sliver production while assuming the fibre extraction and preparation methods are similar. The six EICFs were compared with glass fibre production and the GWP is the only category that could be directly compared. The values GWP for glass fibre production and S1 sliver production (no-till and water-retting) were very comparable. While glass fibre production is resulted in other environmental impacts such as HTP and ODP, flax fibre sliver production is resulted in AP, EP and POCP.

#### **ACKNOWLEDGEMENTS**

JS is grateful to a series of research degree candidates (Nilmini Dissanayake, Amandeep Singh Virk, Aitor Hernandez Michelena and Hossein Mohammad Khanlou) who helped maintain his interest in natural fibre composites and to the delegates at various conferences for their insight into issues arising around LCA.

## REFERENCES

- [1] J Summerscales, N Dissanayake, W Hall and AS Virk, [A review of bast fibres and their composites. Part 1: fibres as reinforcements](#), Composites Part A: Applied Science and Manufacturing, October 2010, 41(10), 1329-1335.
- [2] J Summerscales, N Dissanayake, W Hall and AS Virk, [A review of bast fibres and their composites. Part 2: composites](#), Composites Part A: Applied Science and Manufacturing, October 2010, 41(10), 1336-1344.
- [3] J Summerscales, AS Virk and W Hall, [A review of bast fibres and their composites. Part 3: modelling](#), Composites Part A: Applied Science and Manufacturing, January 2013, 44(1), 132-139.
- [4] NPJ Dissanayake and J Summerscales, [Life Cycle Assessment for natural fibre composites](#), Chapter 8 in VK Thakur (editor): Green Composites from Natural Resources, Taylor and Francis Group LLC, USA, 2014, pp 157-186. ISBN 978-1-4665-7069-6.
- [5] J Summerscales and S Grove, [Manufacturing methods for natural fibre composites](#), Chapter 7 in Alma Hodzic and Robert Shanks (editors): Natural Fibre Composites: materials, processes and properties, Woodhead Publishing, Cambridge, 2014, pp 176-215. ISBN 978-0-85709-524-4 (print). ISBN 978-0-85709-922-8 (online).
- [6] J Summerscales and C Gwinnett, Forensic identification of bast fibres, Chapter 5 in Dipa Roy (editor), The Industrial Development of High-performance Biocomposites, Elsevier/Woodhead, June 2017, 125-164. ISBN 978-0-08-100793-8.
- [7] T Ekvall and G Finnveden, [Allocation in ISO 14041—a critical review](#), Journal of Cleaner Production, 2001, 9(3), 197–208.
- [8] ISO 14040:2006, [Environmental Management - Life Cycle Assessment - principles and frameworks](#), International Organization for Standardization, Geneva, 31 July 2006 (reviewed and confirmed in 2016). ISBN 0-580-48992-2.
- [9] ISO 14044:2006, [Environment Management - Life Cycle Assessment - requirements and guidelines](#), International Organization for Standardization, Geneva, 31 July 2006 (reviewed and confirmed in 2016). ISBN 0-580-48677-X.
- [10] NPJ Dissanayake, J Summerscales, SM Grove and MM Singh, [Energy use in the production of flax fiber for the reinforcement of composites](#), Journal of Natural Fibers, 2009, 6(4), 331-346
- [11] NPJ Dissanayake, J Summerscales, SM Grove and MM Singh, [Life Cycle Impact Assessment of Flax Fibre for the Reinforcement of Composites](#), Journal of Biobased Materials and Bioenergy, , September 2009, 3(3), 245-248.
- [12] A Le Duigou, P Davies and C Baley, [Environmental impact analysis of the production of flax fibres to be used as composite material reinforcement](#). Journal of Biobased Materials and Bioenergy, 2011, 5, 153–165.
- [13] ISO/TR 14047:2003(E), [Environmental Management – Life Cycle Impact Assessment – Examples of Application of ISO14042](#), International Organization for Standardization, Geneva, 11 December 2003 (revised by ISO/TR 14047:2012). ISBN 0-580-43112-6.
- [14] A Azapagic, A Emsley and I Hamerton, Polymers, the Environment and Sustainable Development, John Wiley & Sons, March 2003, ISBN 0-471-87741-7.
- [15] A Azapagic, S Perdan and R Clift (editors), Sustainable Development in Practice - Case Studies for Engineers and Scientists, John Wiley & Sons, May 2004. ISBN 0-470-85609-2. Second edition, 2011: ISBN 978-0-470-71872-8.
- [16] Ecoinvent Centre: Swiss Centre for Life Cycle Inventories. 2010 [24-05-2010], available from: <http://www.ecoinvent.org/database/>
- [17] DR Montgomery, [Dirt: The Erosion of Civilizations](#), University of California Press, Berkeley & Los Angeles CA, April 2012. ISBN 978-0-520-27290-3.
- [18] BS 8905:2011, [Framework for the assessment of the sustainable use of materials. Guidance](#), British Standards Institution, London, 2011.
- [19] United Nations (UN) Human Rights Council, [Report of the Special Rapporteur on the right to food](#), UN General Assembly Report A/HRC/34/48, 24 January 2017.

**Appendix 1: Global Warming Potential (GWP) for the production of flax in the three scenarios:**

<sup>a</sup> Sliver data decreased by 1.2% to correct for mass loss from the spinning operation

	Global Warming Potential (GWP) in kg of CO <sub>2</sub>			Allocation
	Scenario 1	Scenario 2	Scenario 3	
Crop production	2.5	6.5	3.3	Seed
Agro-chemicals	10192	16077	8800	Seed
Retting	0.3	2.3	12228	Fibre
Scutching	1618	2098	1605	Fibre
Hackling	379	497	384	Fibre
Spinning	4113	4111	4111	Fibre
<b>Sliver (pre spinning)</b>	<b>12045</b>	<b>18457</b>	<b>22744</b>	
<b>Yarn (post-spinning)</b>	<b>16305</b>	<b>22792</b>	<b>27131</b>	
<b>Sliver (post-harvest/pre spinning)<sup>a</sup></b>	<b>1973 (16%)</b>	<b>2566 (14%)</b>	<b>14217 (63%)</b>	
<b>Yarn (post-harvest/post-spinning)</b>	<b>6110 (37%)</b>	<b>6708 (29%)</b>	<b>18328 (68%)</b>	

**Appendix 2: Acidification Potential (AP) for the production of flax in the three scenarios**

	Acidification Potential (GWP) in kg of SO <sub>2</sub>			Allocation
	Scenario 1	Scenario 2	Scenario 3	
Crop production (diesel)	5.5 x 10 <sup>-3</sup>	14x10 <sup>-3</sup>	7x10 <sup>-3</sup>	Seed
Agro-chemical N fertiliser	142.3	268.6	125.9	Seed
Agrochemical P fertiliser	6.1	7.0	3.2	Seed
Agrochemical pesticides	24x10 <sup>-6</sup>	40x10 <sup>-6</sup>	22x10 <sup>-6</sup>	Seed
Retting (diesel)	640x10 <sup>-6</sup>	5100x10 <sup>-6</sup>	0	Fibre
<b>Sliver (pre spinning)<sup>a</sup></b>	<b>146.6</b>	<b>272.3</b>	<b>127.5</b>	
<b>Yarn (post-spinning)</b>	<b>148.4</b>	<b>275.6</b>	<b>129.1</b>	
<b>Sliver (post-harvest/pre spinning)<sup>a</sup></b>	<b>0 (0%)</b>	<b>0 (0%)</b>	<b>0 (0%)</b>	
<b>Yarn (post-harvest/post-spinning)</b>	<b>0 (0%)</b>	<b>0 (0%)</b>	<b>0 (0%)</b>	

**Appendix 3: Eutrophication Potential (EP) for the production of flax in the three scenarios**

	Eutrophication Potential (EP) in kg of PO <sub>4</sub> <sup>3-</sup>			Allocation
	Scenario 1	Scenario 2	Scenario 3	
Crop production (diesel)	930x10 <sup>-6</sup>	2400x10 <sup>-6</sup>	1200x10 <sup>-6</sup>	Seed
Agro-chemical N fertiliser	62.4	119.8	55.2	Seed
Agrochemical P fertiliser	50.0	83.4	38.0	Seed
Retting (diesel)	110x10 <sup>-6</sup>	850x10 <sup>-6</sup>	0	Fibre
<b>Sliver (pre spinning)<sup>a</sup></b>	<b>111.1</b>	<b>200.7</b>	<b>92.1</b>	
<b>Yarn (post-spinning)</b>	<b>112.4</b>	<b>203.1</b>	<b>93.2</b>	
<b>Sliver (post-harvest/pre spinning)<sup>a</sup></b>	<b>0 (0%)</b>	<b>0 (0%)</b>	<b>0 (0%)</b>	
<b>Yarn (post-harvest/post-spinning)</b>	<b>0 (0%)</b>	<b>0 (0%)</b>	<b>0 (0%)</b>	

**Appendix 4: Human Toxicity Potential (HTP) for the production of flax in the three scenarios**

	Human Toxicity Potential (HTP) in kg			Allocation
	Scenario 1	Scenario 2	Scenario 3	
Crop production (diesel)	6.2 x 10 <sup>-3</sup>	16x10 <sup>-3</sup>	8.3x10 <sup>-3</sup>	Seed
Agro-chemical N fertiliser	16.4	23.4	14.5	Seed
Agrochemical P fertiliser	10.0	11.5	5.2	Seed
Agrochemical pesticides	4900x10 <sup>-6</sup>	9500x10 <sup>-6</sup>	4400x10 <sup>-6</sup>	Seed
Retting (diesel)	720x10 <sup>-6</sup>	5700x10 <sup>-6</sup>	0	Fibre
<b>Sliver (pre spinning)<sup>a</sup></b>	<b>26.0</b>	<b>34.5</b>	<b>19.5</b>	
<b>Yarn (post-spinning)</b>	<b>26.4</b>	<b>34.9</b>	<b>19.7</b>	
<b>Sliver (post-harvest/pre spinning)<sup>a</sup></b>	<b>0 (0%)</b>	<b>0 (0%)</b>	<b>0 (0%)</b>	
<b>Yarn (post-harvest/post-spinning)</b>	<b>0 (0%)</b>	<b>0 (0%)</b>	<b>0 (0%)</b>	

**Appendix 5: Aquatic Toxicity Potential (ATP) for the production of flax in the three scenaria**

	Aquatic Toxicity Potential (ATP) in $m^3 \times 10^{12}$			Allocation
	Scenario 1	Scenario 2	Scenario 3	
Agrochemical pesticides	1794	2067	942	Seed
<b>Sliver (pre spinning)<sup>a</sup></b>	<b>1772</b>	<b>2042</b>	<b>930</b>	
<b>Yarn (post-spinning)</b>	<b>0</b>	<b>0</b>	<b>0</b>	
<b>Sliver (post-harvest/pre spinning)<sup>a</sup></b>	<b>0 (0%)</b>	<b>0 (0%)</b>	<b>0 (0%)</b>	
<b>Yarn (post-harvest/post-spinning)</b>	<b>0 (0%)</b>	<b>0 (0%)</b>	<b>0 (0%)</b>	

**Appendix 6: Ozone Depletion Potential (ODP) for the production of flax in the three scenaria**

Units translated to nanograms for integer values

	Ozone Depletion Potential (ODP) in ng of CFC-11			Allocation
	Scenario 1	Scenario 2	Scenario 3	
Crop production (diesel)	7400	18000	9400	Seed
Retting (diesel)	860	6300	0	Fibre
<b>Sliver (pre spinning)<sup>a</sup></b>	<b>8161</b>	<b>24001</b>	<b>9287</b>	
<b>Yarn (post-spinning)</b>	<b>8260</b>	<b>24300</b>	<b>9400</b>	
<b>Sliver (post-harvest/pre spinning)<sup>a</sup></b>	<b>850 (10%)</b>	<b>6224 (26%)</b>	<b>0 (0%)</b>	
<b>Yarn (post-harvest/post-spinning)</b>	<b>860 (10%)</b>	<b>6300 (26%)</b>	<b>0 (0%)</b>	

**Appendix 7: Photochemical Oxidants Creation Potential (POCP) for the production of flax in the three scenaria**

	Photochemical Oxidants Creation Potential (POCP) in $kg \times 10^{-6}$ of ethylene			Allocation
	Scenario 1	Scenario 2	Scenario 3	
Crop production (diesel)	10	24	13	Seed
Retting (diesel)	1.2	8.7	0	Fibre
<b>Sliver (pre spinning)<sup>a</sup></b>	<b>11.0</b>	<b>32.3</b>	<b>12.8</b>	
<b>Yarn (post-spinning)</b>	<b>11.2</b>	<b>32.7</b>	<b>13</b>	
<b>Sliver (post-harvest/pre spinning)<sup>a</sup></b>	<b>13%</b>	<b>27%</b>	<b>0 (0%)</b>	
<b>Yarn (post-harvest/post-spinning)</b>	<b>10.7%</b>	<b>27%</b>	<b>0 (0%)</b>	

**Appendix 8: Non-Renewable/Abiotic Resource Depletion Potential (NRADP) for the production of flax in the three scenaria**

	Non-Renewable/Abiotic Resource Depletion Potential (NRADP: parts per $10^{15}$ )		
	Scenario 1	Scenario 2	Scenario 3
<b>Sliver</b>			
Coal	1.0	1.3	6.8
Gas	600	800	4400
Oil	2000	4500	7400
<b>Yarn</b>			
Coal	3.1	3.4	9.2
Gas	2000	2200	5900
Oil	3900	6500	9600

**Appendix 9: The LCIA results from EcoInvent v2.0 per tonne of glass fibre production**

EICF	LCIA - Results from EcoInvent v2.0
GWP (kg CO <sub>2</sub> -Eq)	2634.5
AP (kg SO <sub>2</sub> -Eq)	15.66
EP (kg PO <sub>4</sub> -Eq)	1.37
HTP (kg 1, 4-DCB-Eq)	8763.7
ODP (kg-CFC11-Eq)	0.00036
POCP (kg Ethylene-Eq)	0.59