



UNIVERSITY OF
PLYMOUTH

PEARL

PHD

Optimising Power Consumption For Smart Home Communities

Yaseen, Yaseen Saleem

Award date:
2019

Awarding institution:
University of Plymouth

[Link to publication in PEARL](#)

All content in PEARL is protected by copyright law.

The author assigns certain rights to the University of Plymouth including the right to make the thesis accessible and discoverable via the British Library's Electronic Thesis Online Service (EThOS) and the University research repository (PEARL), and to undertake activities to migrate, preserve and maintain the medium, format and integrity of the deposited file for future discovery and use.

Copyright and Moral rights arising from original work in this thesis and (where relevant), any accompanying data, rests with the Author unless stated otherwise*.

Re-use of the work is allowed under fair dealing exceptions outlined in the Copyright, Designs and Patents Act 1988 (amended), and the terms of the copyright licence assigned to the thesis by the Author.

In practice, and unless the copyright licence assigned by the author allows for more permissive use, this means,

That any content or accompanying data cannot be extensively quoted, reproduced or changed without the written permission of the author / rights holder

That the work in whole or part may not be sold commercially in any format or medium without the written permission of the author / rights holder

* Any third-party copyright material in this thesis remains the property of the original owner. Such third-party copyright work included in the thesis will be clearly marked and attributed, and the original licence under which it was released will be specified. This material is not covered by the licence or terms assigned to the wider thesis and must be used in accordance with the original licence; or separate permission must be sought from the copyright holder.

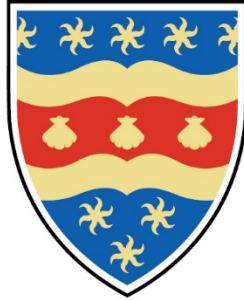

UNIVERSITY OF PLYMOUTH

Optimising Power Consumption For Smart Home Communities

by

Yaseen Saleem Yaseen

A thesis submitted to the University of Plymouth
in partial fulfilment for the degree of

DOCTOR OF PHILOSOPHY

School of Computing, Electronics and Mathematics

July 2019

COPYRIGHT STATEMENT

This copy of the thesis has been supplied on condition that anyone who consults it is understood to recognise that its copyright rests with its author and that no quotation from the thesis and no information derived from it may be published without the author's prior consent.

Abstract

Optimising power consumption for smart home communities

Yaseen Yaseen

Households' demand-side energy management systems are considered as primary units for optimising power consumption in a community-based environment by peak load minimisation. These peak periods are expensive for energy providers and consumers. The power management in one community can reduce power consumption fluctuations and improve the response to power price variations per day. The fluctuation demand is not convenient in terms of planning, expenses, and logistics. Therefore, more stable demand will allow suppliers to use cheaper resources and avoid the need for additional resources, which are normally used to meet the load demand at peak times.

In the current literature, the focus is on reviewing the shortcoming of methods that address load demand stability. This load demand stability is usually measured by the peak-to-average ratio (PAR) of the households' load demand. Therefore, the best PAR is when the peak doesn't go beyond average by minimise PAR values and is as close as possible to one. However, there is a notable absence of empirical research investigating aspects joining community-based solutions, appliance-by-appliance analysis, and using real-load profiles in energy management systems. In addition, beyond proposing new energy management systems, prior research assumed users are willing to allow an automatic system to control their power usage unconditionally. This assumption may not hold for a typical environment. Third, suboptimal scheduling patterns to reduce the PAR are obtained using algorithm-based energy management systems. These patterns depend on how the data load profile is structurally parsed; however, using a mathematical model gives the optimal scheduling pattern solution.

In this context, this project aims to reduce these fluctuations to the degree that the demand for energy would be more constant in a 24-hour cycle and closer to the ideal scenario. This will benefit the utility providers, households, and the environment.

First, a novel demand-side management (DSM) stage is proposed to optimise power consumption patterns of R-users in individual and community-based scenarios. This

new DSM focuses on a community-based allocation of power demand for minimising the peak load. Utilising the decisions made by the proposed DSM, single R-users minimise the PAR of the power system by shifting consumption to off-peak times individually. However, it is more effective when the policy is applied in the community-based nature of the demand and allocation is considered. This intuition is supported by the empirical results. Second, a novel energy management stage within an energy management system (EMS) is proposed to optimise power consumption and to reduce the overall PAR for a community of R-users. This new stage is merged as a new component to the first novel DSM stage. The above two proposed systems were evaluated on a set of 15 R-users' load profiles, using randomly assigned willingness values, by measuring the load of each individual R-user profile during a 24-hour cycle with a 10-minute resolution. The results show the suggested algorithm provides an average PAR reduction, which is 12.37% for the single R-user scenario and 22.66% for the multi-R-user scenario. The addition of willingness reduces the benefits' reach to 10.34% for the single R-user scenario and 16.25% for the multi- R-user considering their willingness.

Third, a novel energy management stage for PAR minimisation, based on a mixed-integer nonlinear programming (MINLP) mathematical model is proposed. MINLP is formulated to minimise the PAR in single and community-based scenarios through providing orders, which include the optimal scheduling power usage patterns of shiftable appliances during a day with a 10-minute resolution. The measurements show the proposed framework's effectiveness, which provides a significant PAR reduction up to 50% in the community-based scenario.

Table of Contents

AUTHOR'S DECLARATION	XII
1. INTRODUCTION	1
1.1 AIMS AND OBJECTIVES	6
1.2 THESIS STRUCTURE.....	8
2. BACKGROUND/LITERATURE SURVEY	10
2.1 COMPONENTS OF ENERGY CONSUMPTION	10
2.1.1 Smart home	11
2.1.2 Energy distribution network.....	14
2.1.3 Energy suppliers	15
2.1.4 Energy pricing	18
2.2 THE OPTIMISATION CONTEXT OF POWER CONSUMPTION	26
2.2.1 Motivations and advantages of power optimisation.....	27
2.2.2 Power optimisation environment, and current methods	30
2.3 PRIOR WORK IN POWER USAGE OPTIMISATION AND PAR REDUCTION	35
2.3.1 Energy demand management tools	36
2.3.2 Users' willingness for using energy demand management tools.....	49
2.3.3 Mathematical modelling approaches	52
2.4 RELATED WORK DISCUSSION AND CONCLUSION.....	56
3. PROPOSED PAR OPTIMISATION METHODS	62
3.1 RESEARCH CONTEXT AND STATEMENT	63
3.2 A NOVEL DEMAND-SIDE MANAGEMENT (DSM) FOR POWER OPTIMISATION.....	65
3.2.1 Introduction	65

3.2.2 DSM system environment.....	66
3.2.3 A novel algorithm in DSM	71
3.2.4 Empirical testing using real-load data profiles.....	77
3.3 WILLINGNESS-CONTROLLED RESIDENTIAL ENERGY MANAGEMENT SYSTEM (EMS).	83
3.3.1 Introduction.....	83
3.3.2 EMS system environment.....	84
3.3.3 A novel algorithm in EMS.....	89
3.3.4 Empirical testing using real-load data profiles.....	92
3.4 SYSTEM FRAMEWORK FOR A NOVEL MATHEMATICAL MODELLING OPTIMISATION	95
3.4.1 Introduction.....	95
3.4.2 Formulation.....	96
3.4.3 Model integration into the environment.....	101
3.4.4 Empirical testing using real-load data profiles.....	105
3.5 CONCLUSION	113
4. EXPERIMENTS AND RESULTS	115
4.1 DATA SOURCE ENVIRONMENT	115
4.1.1 System formulation and the evaluation metrics	119
4.2 DSM EXPERIMENTAL METHODOLOGY AND RESULTS	120
4.3 EMS WITH R-USERS' WILLINGNESS EXPERIMENTAL METHODOLOGY AND RESULTS	131
4.4 MATHEMATICAL MODELLING SYSTEM EXPERIMENTAL METHODOLOGY AND RESULTS	149
4.5 CONCLUSION	163
5. COMMUNICATION/ OVERALL ARCHITECTURE.....	164

5.1 GENERAL COMMUNICATION ARCHITECTURE FOR SCHEDULING METHODS OF OPTIMISING POWER CONSUMPTION	164
5.2 CONCLUSION	174
6. CONCLUSION.....	178
6.1 ACHIEVEMENTS OF THE RESEARCH	178
6.2 LIMITATIONS OF THE RESEARCH PROJECT.....	181
6.3 THE FUTURE OF ENERGY MANAGEMENT SYSTEMS	184
7. REFERENCES	186
8. APPENDIX	ERROR! BOOKMARK NOT DEFINED.

List of Figures

Figure 1 Diagram of generators sources/kinds to satisfy demand	18
Figure 2 Main parts of pricing decision (Celebi and Fuller, 2007)	20
Figure 3 Peak time prices compared with off-peak time prices (Avalon Energy Services, 2014).....	23
Figure 4 The monthly differences in energy consumption 2004 and 2005 (Yohanis et al., 2008).....	24
Figure 5 Proposed system for DSM based on community interaction.....	70
Figure 6 Historical load demand information watt (W)	72
Figure 7 Load demand information at the current time slot in watts (W)	74
Figure 8 Flow chart of load profile rescheduling	77
Figure 9 Energy management control program in a single R-user scenario	81
Figure 10 Energy management control program in a multi-R-user scenario.....	82
Figure 11 The architecture of the proposed willingness stage	86
Figure 12 Energy management controlling flowchart for multiple users with users' willingness scenario.....	93
Figure 13 Unexpected high load appliances. The dotted line represents the origin load while the solid line represents the optimised load	94
Figure 14 System architecture for the mathematical model	103
Figure 15 Two power signals before and after applying the potential power usage threshold.....	110
Figure 16 Residuals between two power signals after applying the threshold	111
Figure 17 Power consumption for (a-solid line) original household demand and (b-dotted line) proposed DSM algorithm.....	122

Figure 18 Power usage of all R-users in group-1 (a-dotted line) original household demand and (b-green line) proposed DSM algorithm.	127
Figure 19 Power usage of all R-users in group-2 before changing the average load value	130
Figure 20 The power usage of all R-users in group-2 after adjusting the average load value	131
Figure 21 Overall power usage of shiftable and non-shiftable appliances for 24 hours for R-users.	153
Figure 22 Comparison of the load profile patterns of three different R-users User-1, 2, and 15 24 hours before and after applying the proposed system.....	160
Figure 23 Load profile patterns of all R-users in the community during 24 hours before and after applying the proposed system	162
Figure 24 Overall communication architecture between household appliances and a community-based server.....	167
Figure 25 Three available energy management systems for power optimisation.	174

List of Tables

Table 1 Different energy source costs (Celebi and Fuller, 2007)	21
Table 2 TOU pricing in Ontario (Celebi and Fuller, 2007)	22
Table 3 The resulting PAR and daily cost for 10 consumers.....	41
Table 4 Energy costs based on power limits.....	43
Table 5 The impact of the proposed DSM algorithm in the single R-user scenario	123
Table 6 Comparison before and after applying the proposed system for four groups.....	128
Table 7 The breakdown of PAR optimisation results for single users with willingness	136
Table 8 The total number of shifting requests and users' failure shifting requests counter during a day	141
Table 9 The average of failure shifting requests and the average of optimized PAR through the same R-users in different appliance preferences.....	144
Table 10 Community-based optimisation of all groups with the individual willingness values of all R-users	145
Table 11 Comparison of the PAR optimisation with and without a community-based solution, considering R-users' willingness	147
Table 12 Comparisons between measured and regularized power usage of shiftable appliances of one R-user in a day.....	151
Table 13 PARs before and after the regularization procedure for different R-users.....	154

Table 14 The PAR results of an R-user community before and after the regularization process 156

Table 15 The results were obtained by applying the proposed MINLP model to 15 R-users 157

Table 16 A sample of the data power profile contents. 171

Table 17 The comparison of the PAR optimisation with and without willingness with taking into account the single and community-based solution 181

Acknowledgment

Most of all, I would like to thank Allah Almighty for giving me the health, knowledge, and capability to undertake the PhD study and to persevere in completing it satisfactorily. I do thank Him so much for His uncountable favour and without His help, this work would not have been possible.

I would like to express my grateful thanks to my Director of Studies **Dr Bogdan Ghita** for his agile guidance. I also wish to extend my profound thanks to **Dr David Lancaster**, my supervisor, whose passion and willingness to help has been truly inspirational. Special thanks also have to go to my supervisor **Dr Alma Rahat** who has been recently supportive throughout my study.

I owe a debt of gratitude to my beloved parents my father (**Saleem**) and my mother (**Zainab**) for their endless encouragement and support. Any success that might be resulted, optimistically, should help me making them proud and happy. I should not forget to thank my dear siblings who have been supportive without any hesitation, many thanks to them all.

My countless love, and appreciation must go to my wife (**Elaf**), my daughter (**Noor**), and my little son (**Yusuf**) who have been very patient and understanding throughout this journey, spending days, nights, and sometimes even holidays without me. I hope the potential success of this study will compensate some of what they have missed.

I am also very thankful to my best friends **Abdulrahman Alruban**, **Hussam Mohammed** and **Leith Abed**, for their assistance and support during the PhD endeavour. I thank my colleagues at the Centre for Security, Communications and Network Research (CSCAN) for their encouragement and friendship throughout the duration of the research.

Finally, I would like to express my sincere thanks to the Republic of Iraq and in particular the Higher Committee for Education Development for granting me a scholarship and sponsoring my PhD study.

Author's Declaration

At no time during the registration for the degree of Doctor of Philosophy has the author been registered for any other University award without prior agreement of the Doctoral College Quality Sub-Committee.

Work submitted for this research degree at the University of Plymouth has not formed part of any other degree either at the University of Plymouth or at another establishment.

This study was financed with the aid of a scholarship from the Higher Committee for Education Development (HCED) in the Republic of Iraq.

Relevant seminars and conferences were attended at which work was often presented and several papers are published:

- Yaseen, Y., Ghita, B., 2017. Peak-to-Average Reduction by Community-Based DSM. 2017 5th IEEE Int. Conf. Smart Energy Grid Eng.
DOI: <https://ieeexplore.ieee.org/abstract/document/8052798>
- Yaseen, Y., Ghita, B., 2019. Willingness Impact to the PAR Optimisation of R-users Community using EMS. Energy Procedia 156, 315-320.
DOI: <https://www.sciencedirect.com/science/article/pii/S1876610218311081>
- Poster in Postgraduate Society Conference, 16th March 2016, Plymouth University.
- Seminar in Postgraduate Society Conference 20th June 2016, Plymouth University.
- Seminar in Eleventh International Network Conference (INC 2016) July 19-21, 2016 Frankfurt, Germany ISBN: 978-1-84102-410-3

Word count of main body of thesis: 36,826 words



Signed

Date

1. Introduction

Smart homes, also called automated homes, are residential buildings connected to each other using communication channels. Each smart home is composed of domestic appliances that incorporate common devices that control the homes' features. In addition to connecting homes and controlling appliances' features, interactive technologies are the main feature that makes these homes 'smart homes'. These smart homes aim to achieve common objectives that benefit the end user, such as energy consumption management and providing comfort and security. Smart home technology does not turn devices on and off only; it can also monitor the internal environment and activities that are undertaken while the house is occupied. Therefore, appliances must increasingly be proactively and automatically involved in the efficient management of electricity consumption. Typically, a smart appliance combines embedded computing, sensing, and communication capabilities to enable intelligent decision-making and optimise its energy usage. The results of these modifications to the technology are that a smart home can now monitor the activities of the occupant of a home and independently operate devices in predefined patterns aiming for good use of power as desired by the national grid. The national grid wants to deal with demand in such a way that they are producing electricity at a

constant level (Harper, 2003; Ricquebourg et al., 2006; Pedrasa et al., 2010; Bouhafs et al., 2014).

However, the problem is that demand is variable, changes quite frequently, and there is no way to manage this demand in a way so it enables the utility to produce energy at a constant level. It is because consumers typically turn their appliances on or off with little or no knowledge of how it affects their usage. To monitor this, they would often look at their meters, which may not be easily accessible as meters are usually located under the stairs or outside the building. As a result, if consumers pay via fixed monthly payments or direct-debit, it makes the relationship between dwellings and energy utilities unclear. Accordingly, the power operation cycle of these appliances leads to daily undesired power consumption patterns and peak load demands. These patterns could be avoided by minimising the peak load demand, which is measured by the peak-to-average ratio (PAR) value, as described in sections 2.2.1 and 2.2.2. PAR minimisation results in efficient usage of resources, which are allocated to generation, transmission, and distribution. Avoiding these undesired power usage patterns leads to important cost benefits for both power producers and power consumers. From the producer perspective, the cost of power generation will be decreased by using cheaper resources and, from the consumers' perspective, the monthly bills will be decreased (Harper, 2011; Saffari et al., 2018).

With increases in power usage in residential buildings, it significantly increases the negative impact of daily undesired power consumption patterns. Power consumption, which occurs in buildings, forms a high percentage compared to major sectors such as the industrial and transportation sector. For example, according to a report by the U.S. Department of Energy, power consumption in buildings occupied 74% of the nation's electricity consumption (Mohsenian-Rad et al., 2010a). The rapid increase of residential power consumption in the last few years was also discussed by Bouhafs et al. (2014), who reported that the residential electricity usage during the last 10 years increased to 12% and will continue to grow to about 25% by 2020. In the UK, it has been revealed that power consumption per person has increased by 18% between 1970 to 2000 (DTI, 2002; Yohanis et al., 2008). Although one domestic appliance may consume less than 1 kWh per day, appliance usage generally results in large demand for electricity at peak times (Wood and Newborough, 2003).

There is a high amount of household energy consumption that is not necessary and management to avoid this amount is crucial. This undesired energy amount occurs because occupants' behaviour does not match to the supplier's desires. For example, the washing machine or heater could be turned off for 30 minutes during peak times or the freezer could be turned off for 10 minutes. Recently, Saad Al-

Sumaiti et al., (2014) showed that 41% of residential consumption is not needed based on estimating the types of unneeded energy use. 10-30% of total residential power consumption could be saved by changing households' behaviour. To overcome the undesired power usage patterns by residential consumers, there are two general approaches for energy consumption management in buildings: reducing consumption and shifting consumption. The former can be applied by improving appliance design and consumers' awareness (Palmborg, 1986; Mullaly, 1998). For appliance design, unneeded energy consumption happens because of delays in replacing older, less-efficient electronics with new efficient electronics and because customers fail to remember energy consumption when purchasing appliances. For consumers' awareness, unneeded energy consumption happens because the use of analogue meters is not based on real-time measurements (Saad Al-Sumaiti et al., 2014). The latter, shifting consumption, is an important approach for practical solutions to shift high-load household appliances to off-peak hours to reduce the peak-to-average ratio (PAR) in load demand without trying to reduce the overall energy consumption. With all the statistics about increasing power consumption in the residential sector, as previously explained, this shifting consumption approach is highly recommended for power management by sharing the power consumption of households in one community. The power consumption management in one

community is considered as a primary unit of power consumption management to reduce the aggregated daily peak load.

However, in the shifting consumption approach, other factors affect power consumption management, namely, power grid, use of appliances, and energy management systems between energy producer and consumers. The conventional elements are not compatible with power management methods because this management requires two-way communication to overcome the management process. Alternatively, new components of power consumption management with two-way communication are required to aid consumers in making more intelligent decisions when operating their major home appliances. Examples of these new components are control devices for smart appliances located in smart homes, smart grids (SGs) for power dispatch, and new pricing policies by providers to be adequate with these new components. One significant benefit of power management of these components is minimising the peak load and reducing the fluctuations of power demand per day. It is, therefore, necessary to improve on existing power consumption management systems to make significant savings for energy suppliers and consumers by monitoring, managing, and conserving energy usage.

There is a high level of demand for controlling and scheduling appliances. It is possible for users to manage their usage via efficient energy management systems

(Harper, 2011; Saffari et al., 2018). Therefore, this thesis discusses how to enable smart homes and appliances to help energy companies to produce a constant level of energy by allowing energy providers or another third party to manage the appliances that can be shifted, such as washing machines and dishwashers. This research presents three novel energy management systems and analyses these systems with real load profiles. The common objective of novel energy management systems is to minimise undesired power consumption patterns produced by appliances operating in the residential sector. This chapter briefly presents the aims and objectives of three novel energy management systems that optimise energy consumption by minimising the peak load demand of the residential sector.

1.1 Aims and objectives

In this thesis, the aim is to design, implement, and evaluate a system that minimises energy usage fluctuations and the PAR value. By this minimisation, energy utilities can plan energy provision in a more efficient manner by avoiding expensive on-demand energy sources in favour of cheaper more uniform, inertial energy resources. As a result, the added value for the customer is that expected energy prices are likely to decrease. This decrease is proportional to the amount of realigning of energy usage. The more customers realign their energy usage, the cheaper energy cost will be.

This study started with the aim to introduce PAR minimisation sequentially both for individual and community-based R-users. Based on the encouraging results, the second stage applied R-users' willingness, which has been added to enhance the basic first stage. This willingness value is reflected in R-users' convenience regarding scheduling decisions for shifting (realigning) power consumption. Whereby, the previous two stages provided sub-optimal scheduling solutions, finally, in the last part of this study, a mathematical model-based solution is investigated to produce an optimal scheduling solution for power usage.

All the new stages are influenced by different residential load parameters—demand type (e.g., shiftable and non-shiftable), specific control algorithm, short and accurate meter readings, to mention just a few—, which impact the optimised scheduling decisions of the R-users' power usage. Therefore, this study aims to implement an appliance-by-appliance scheduling level, which is a bottom-up model that can be easily applied to develop new control algorithms and disaggregation of electric consumption. Each stage has a fundamentally different algorithm responsible to optimise the given load demand. This study is also aimed at evaluating all the proposed stages based on real load profile data of households, which, in turn, leads to valuable performance evaluation and easily mapping it to the real environment.

1.2 Thesis structure

The rest of the thesis is structured as follows. Chapter 2 follows with a comprehensive review of optimisation approaches in R-users' power consumption. It describes in greater detail the optimisation's contextual challenges, advantages, and current tools. The last section of the chapter focuses on analysing the state of the art for PAR reduction and power usage optimisation, summarising the current achievements and limitations.

Drawing from the current research, Chapter 3 proposes several novel stages to energy management systems, all focused primarily on new algorithms, mathematical formulations, and appropriate system models to implement these new novel energy management systems. Two main algorithms are described, which are novel DSM and EMS. In addition, this chapter describes the impact of the real-load profile in the system's model design for all three novel stages.

Chapter 4 validates the performance of the three novel energy management stages by applying real load profiles as input and allowing the new stages to reschedule the R-users' energy consumption. The experimental results were analysed and discussed in detail to show the impact of various factors on the output. These factors are the performance of the three novel stages during three loads at different periods in one day, which are off-peak, mid-peak, and peak times. Moreover, the

optimisation difference between single loads and community loads was discussed using real load profiles. After validating the proposed energy optimisation algorithms, Chapter 5 outlines a communication architecture that may be used to interconnect the energy management systems and provide an implementation to be used in a smart city environment.

The thesis concludes with Chapter 6, which summarises the research and highlights its key contributions, achievements, and limitations. It also contains a discussion of potential areas for future research.

2. Background/ literature survey

The scheduling optimisation of power consumption enables households to adapt their power consumption according to network loading and to limit their peak load demands. Therefore, the scheduling optimisation approaches to power consumption in the residential sector have significant importance. These approaches allow for reducing fluctuations in terms of instantaneous power load, as well as long-term power consumption and, consequently, contribute to improving the energy efficiency of the whole grid, as described in Chapter 1. This chapter presents some background on optimising R-users' power consumption. It begins with an overview of the energy generation, distribution, and consumption environment. As a result of the variation in generation resources, the concept of variable pricing is also introduced. The second part moves on to describe in greater detail the current state of the art in the area of power consumption optimisation, together with the contextual challenges, advantages, and current tools. The last section of this chapter summarises the achievements and limitations of the existing research in power usage optimisation by PAR reduction.

2.1 Components of energy consumption

To explain the daily energy peak demand issue, four components that affect households' energy consumption are discussed in this section. First, smart homes

are briefly reviewed, which are the main electricity demand component. Second, the electricity distribution network is discussed, which is used to transport the energy between households and generators. Third, generation resources categories are studied, which are used according to the amount of energy demand variation. Finally, the pricing context to govern the energy cost for households is reviewed. This pricing review describes how energy costs depend on the generation resources category used during each specific period. Each resource is used according to the demand level. The following sections are brief explanations of each of the aforementioned four components.

2.1.1 Smart home

The concept of the smart home was first introduced in 1984 by the American Association of House Builders (AAHB). The concept focused on environmental friendliness, particularly using photovoltaic panel systems and recycling wastewater (Harper, 2003). In September 2003, the Housing Learning and Improvement Network defined a 'smart home' as *'a dwelling incorporating a communications network that connects the key electrical appliances and services, and allows them to be remotely controlled, monitored or accessed'* (Jiang et al., 2004). Energy resources are the basic source for domestic needs, such as cooking, heating, and for use in electric motors for fridges, washing machines, and other white goods. The

11

electricity usage of these appliances has witnessed an unexpected increase in recent years. In light of this increase, users' energy consumption costs, whether electricity or gas, has also increased. In this context, energy management is necessary for reducing energy consumption and minimising energy costs. Smart homes incorporate common devices that control features of the home. Smart home technology has developed so that almost any electrical component within the house can be controlled (Ricquebourg et al., 2006). Controlling the operation time of these appliances has led to a reduction in the peak load by modifying the timing of demand (Rinkinen et al., 2019).

In terms of energy saving applications in a smart home environment, several applications that reveal statistical user energy consumption patterns or allow for visualising power consumption data have been used, such as Aztech, Cent-A-Meter, and EML 2020H (Bouhafs et al., 2014). However, there is not enough expanded research or industrial work towards power consumption management applications. However, the current power management applications overall are focused towards collecting information about power usage then presenting them to inform users of their power consumption, so they are aware and in control of their usage. Moreover, some energy retailers, such as British Gas, have shown an interest in providing users

with energy consumption tracking and can set up user alerts if users exceed limits (Bouhafs et al., 2014).

An unexpected increase of people connected to the traditional power grid and high load at peak times can lead to the power service stopping for a short time (blackout), such as in the Northeast of America in 2003 and in India in 2012. Recent studies show that 40% of greenhouse gas emissions are caused by power generation. To enable efficient dispatch of electricity power among smart houses, a smart grid (SG) is used rather than the traditional power grid. The smart grid offers several technologies such as demand response (DR), which offers utilities the possibility to interact with appliances and electrical devices within customers' homes and buildings and allow them to alleviate the stress on the power grid during peak demand periods by moderating electricity demand. For example, it could provide constant information to the utilities about the energy usage patterns of their customers, which will allow them to closely monitor, shift, and balance the power load in ways that could optimize energy usage and avoid congesting certain parts of the grid. The advanced metering infrastructure (AMI) is another of the main applications in future smart power grids. The AMI allows utilities to interact with electricity meters, allowing for the real-time measurement of energy usage. AMI systems with this two-way communication feature allow utilities to send pricing

signals to alert customers of critical peak pricing periods. Such direct communication to customers could further encourage conservation during peak periods and enable utilities to implement direct control of demand-side management. A major application of the smart grid is the home energy management system (HEMS). This application enables households to centralise the management of services in a house, provides all-round functions for internal information exchange, and helps to keep them in contact with the outside world. It also helps households optimise their living style by rearranging the day-to-day energy usage schedule and enables them to reduce bills from by reason of energy consumption in the house. Driven by the aforementioned causes, SG appears to adopt new technologies on traditional power grids, such as computing-based remote control, communication and digital processing (Bouhafs et al., 2014). These technologies are important features of the power management of connected houses.

2.1.2 Energy distribution network

Several reasons such as climate change, finite natural resources, and the average age of the current power grid, which is 40 years old, have led to the significant need to find an alternative power grid infrastructure. Therefore, academia and industrial communities have developed a new energy distribution policy called the smart grid (SG) (McDonald, 2008; Costanzo et al., 2011; Bouhafs et al., 2014). SGs provide

two-way communication for meter readings between users and users with the supplier in the self-registration of meters and the self-reconfiguration of meters after failure to connect (Hart, 2008; Costanzo et al., 2011). A major application of SGs is home energy management systems, which enable residents to schedule their appliances and reduce bills by peak load time notifications (Javaid et al., 2013). SGs also provide feedback through the system, sense grid stress, and reduce their power use during peak demand periods. For more justification about the need for changing from traditional power grids to SGs see this Rehmani et al., (2016) study. Smart grids adopt mesh networks as communication technology to fulfil the wide range of functionalities expected from the modern electricity grid. A mesh network is a communication platform between the smart homes and the energy suppliers using the mesh radio network. It communicates with smart homes by authorized entities, using a third-party telecommunication network through passwords. In general, it is used in a specific geographic region where smart meters are given to a limited number of individuals supplied by different providers' services.

2.1.3 Energy suppliers

Electricity providers use different energy resources (plants) to generate electricity depending on the amount of load demanded at each time. There are two main features to help choose the appropriate energy resource, which is the capacity factor

15

and short-run marginal cost (SRMC). The capacity factor is electricity generation per annum in kilowatt-hours (kWh) divided by the installed capacity in kW and multiplied by 8760 hours in the year. SRMC is the change in total power plant cost from a small and temporary output change, such as changing output by one MW for one hour. SRMC is in units of \$/MWh and the lowest-marginal-cost generators operate, as much as possible, for the entire year. Electrical providers roughly divide the load demand into three categories: base load, medium load, and peak load. For base load responding, the generation plants with the most economical and cheapest fuel for producing kWh are used, for example, nuclear plants. These plants are regarded as having a base load and have a high capacity factor and low short-run marginal cost. For medium load responding, medium load plants are used, such as coal steam plants. For peak load responding, plants with the least capacity factor, because they are usually run during peak hours, and high short-run marginal costs (high fuel cost) are used, such as combustion turbines CT (Khatib, 2003; NECG, 2014).

The chosen energy resource determines the price of residents' power consumption at any time per day. To respond to the daily peak load demand, suppliers use energy resource types that are easy to turn on and off. The process of turning on/off the generators results in changing the temperature and pressure levels, which causes impairment to the generator's components through various damage mechanisms.

Although this process impairs all generator types, medium load and peak load generators are more suited as they are designed specifically for flexible operation. However, when base-load units are required to turn on/off, a large amount of physical damage is afflicted to the boiler, pump, turbine, pipework and the various other components in the generating unit (Troy et al., 2008). Nevertheless, the easier energy resource to turn on/off is always more expensive and not environmentally friendly. Table 1 shows significantly different costs among energy sources during different times of the year. Suppliers use various energy sources, such as hydroelectric, nuclear, coal steam, combustion turbines (CT), and oil/gas steam. Energy suppliers switch between these energy resource types to reduce operating costs. For example, when demand is stable at a single demand level (base load), only cheap resource power generators that are difficult to turn on/off are used, such as nuclear generators. However, when demand increases, it is more cost effective to use sources that are easy to switch on or off but these are expensive, such as gas. Therefore, keeping energy demand stable with few fluctuations leads to improving the energy resource usage costs and is environmentally friendly. Figure 1 shows the energy sources and the load demand amount when each resource is suitable to be used, from low-cost hydroelectric resources to top cost CT in the PJM area (an acronym for Pennsylvania, New Jersey, and Maryland), based on a report

from a US Regional Transmission Organization (RTO) (NECG, 2014). Several price policy agreements are applied to govern the energy costs between the energy generators, retailers, such as British Gas, and households (Celebi and Fuller, 2007). The following section provides an overview of energy costs.

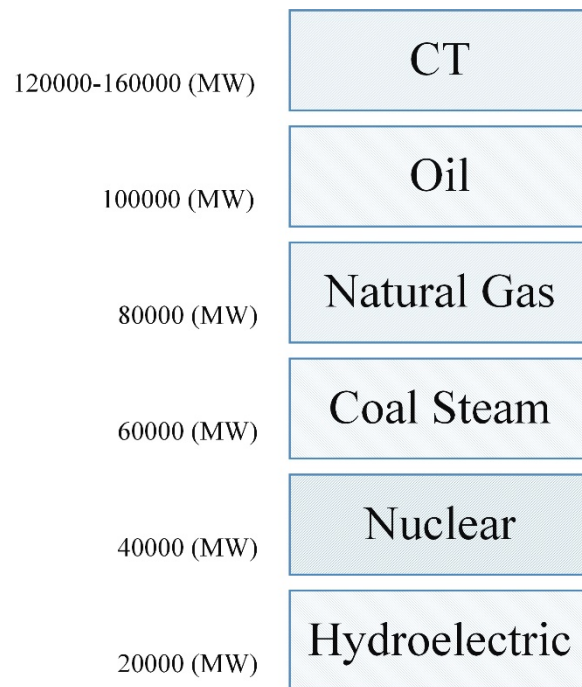

Figure 1 Diagram of generators sources/kinds to satisfy demand (NECG, 2014)

2.1.4 Energy pricing

Energy pricing depends on the time of day in which households pay different prices for the same amount of energy usage, KW. Households pay more money per kwh

during peak times while they pay less money per kwh for the same amount of energy consumption during off-peak times. Therefore, households and factories aim to minimise power consumption during peak times. Obviously, a quick and accurate update of the price by the utility based on the last demand of users is the best pricing strategy to reduce the load at peak times. For example, if peak demand happens in this minute then the supplier ought to compute and notify the consumers of the price quickly. As a result, consumers can reduce their load based on this notification. Otherwise, if the notification by the supplier is received two hours later, there will be an inefficient load response by consumers. Although some research has been carried out on pricing, no single study exists that resolves the pricing strategy with a satisfactory solution. Figure 3 explains the general price decision mechanism. It is clear from this figure there are some factors that govern the price that should be paid by end users. These factors are the expenses of resources used by the generators, households, and the pricing policy adopted by resellers. Generally, two main players determine the price variations: which are providers and households.

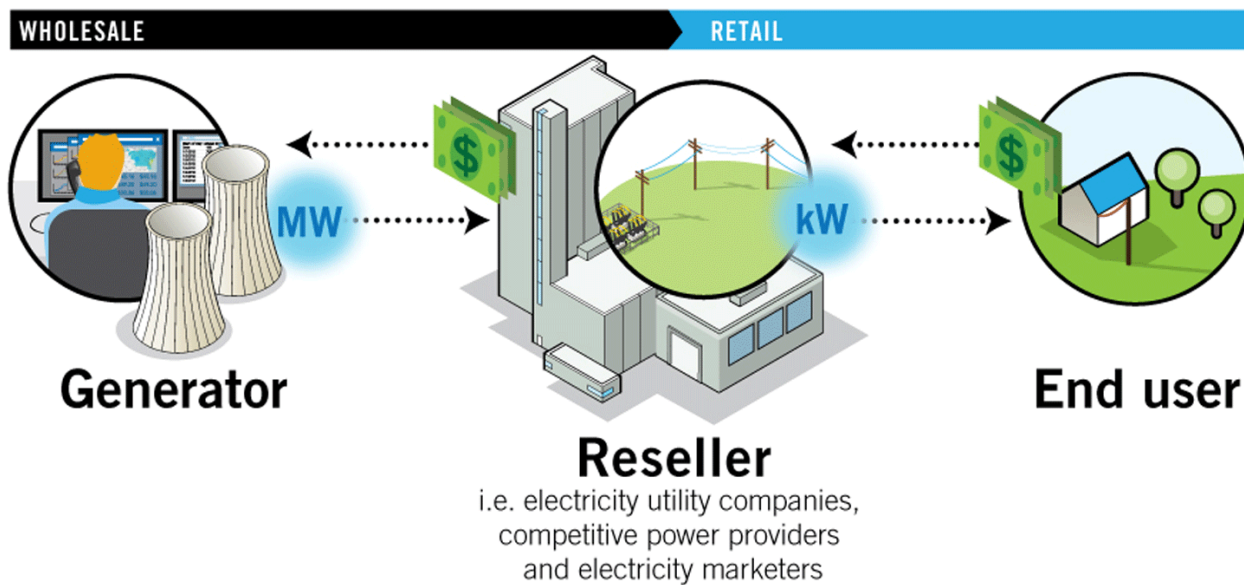

Figure 2 Main parts of pricing decision (Celebi and Fuller, 2007)

One reason behind price variation is the electricity provision chain, which includes wholesale prices, providers, energy generation expenses, and the pricing procedure, which follows selling the energy to end users. The main energy providers need to turn on different types of generators, which use various resources, such as nuclear or gas. These resources have significantly different prices (Celebi and Fuller, 2007). Table 1 shows the price difference depending on which energy source is used. Then, this energy is sold to retail electricity markets (such as EDF, British Gas, and Scottish Power energy in the UK). These retail electricity markets sell energy to consumers based on slightly different agreements depending on the company policy. At the national level, the Energy Policy Act of 2005 (Congress, 2005) reported that:

‘The policy of the United States that time-based pricing and other forms of demand response shall be encouraged, the deployment of such technology and devices that enable electricity customers to participate in such pricing and demand response systems shall be facilitated, and unnecessary barriers to demand response participation in energy, capacity and ancillary service markets shall be eliminated.’

Table 1 Different energy source costs (\$/MWh) (Celebi and Fuller, 2007)

Time	Hydro	Nuclear	Coal	Gas/Oil
T1	1.04	3.79	28.2	61
T2	1.05	3.8	28.4	61.2
T3	1.06	3.81	28.6	61.4
T4	1.07	3.82	28.8	61.6

From the perspective of household behaviour, cold weather, for example, affects household consumption and requires heating of the rooms at particular times per day, which affects energy costs. A study from 2014 explained the real-time wholesale price is affected by peak demand (Avalon Energy Services, 2014). As shown in Table 2, there is a difference in the energy generation cost for one MWh

between on-peak time and off-peak time. It is clear this peak happens for a short time each day, but certainly, it has a high cost for the generation in addition to the need for a high capacity dispatch network, as shown in Figure 4. In the same context, households' power consumption varies per year from one month to another. Yohanis et al., (2008) showed monthly consumption for two years (2004-2005) as shown in Figure 5. As a result, the price of generated power during on-peak times has different values per year. When comparing the peak times through the year, it is clear from Table 2 that there is a high difference during peak times, compared to a minimal increase during off-peak times between T1 and T4 (Celebi and Fuller, 2007). The price definition of on-peak load and off-peak load for the households' power consumption is essential to evaluate the power consumption costs for these households.

Table 2 TOU pricing in Ontario (Celebi and Fuller, 2007)

T(\$/MWh)	Off-peak	Mid-peak	On-peak
T1	24.87	28.20	28.30
T2	27.93	29.42	38.28
T3	28.60	32.61	40.56
T4	28.80	34.97	40.72

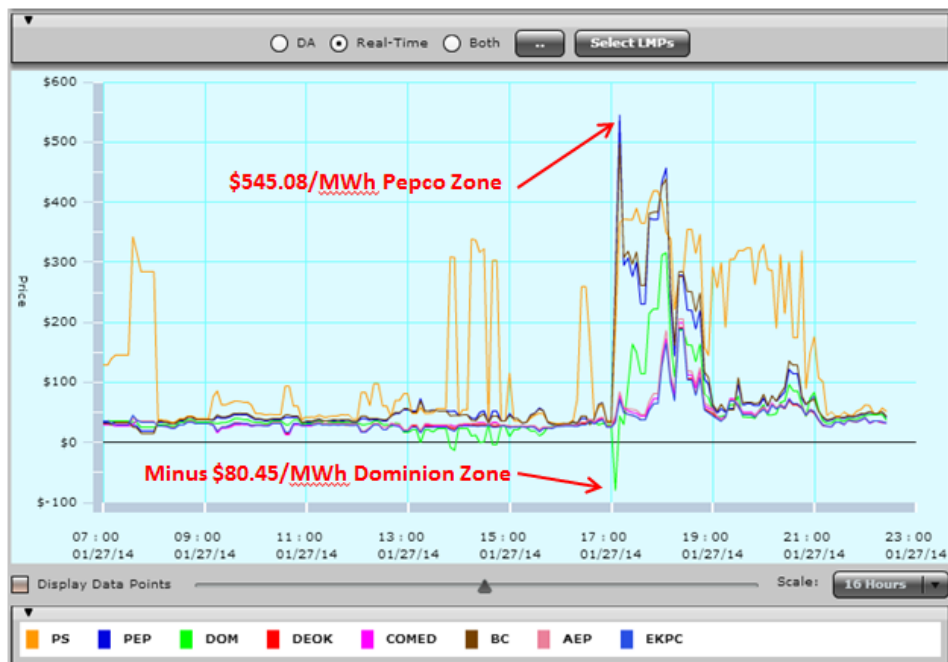

Figure 3 Peak time prices compared with off-peak time prices (Avalon Energy Services, 2014)

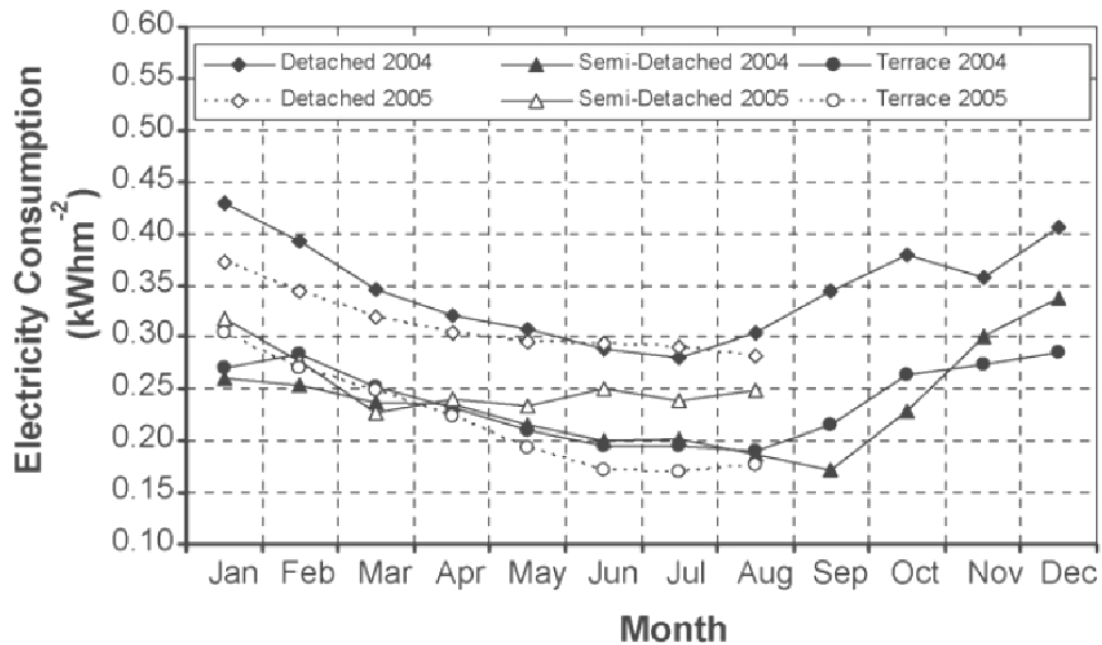

Figure 4 The monthly differences in energy consumption 2004 and 2005 (Yohanis et al., 2008)

The electricity cost normally has two or three different prices per day depending on the load demand each time. For instance, Louisville Gas and Electric Company, Kentucky, USA reported two prices per day for the on-peak and off-peak prices: \$0.13/kwh and \$0.03/kWh, respectively (LG&E, 2015). These two prices were used as base prices to build a simulation model that offers incentives to customers for peak load minimization (Khadgi et al., 2015).

Accurate pricing policy with a response to demand time is essential, as a lack of accurate pricing is the main reason behind peak wholesale prices, such as the frequent power blackouts in California (Borenstein, 2002; Herter, 2007). With regard to pricing policy, Herter, (2007) described three basic kinds of policies to reduce the peak load: direct load control (DLC), time of use (TOU), and real-time price (RTP). DLC is a pricing policy that can be applied to the traditional metering infrastructure. This policy gives monthly periodic credits to households and, in return, gives the utility the ability to control the large electricity usage of end users, such as that caused by air conditioners. However, the DLC has several drawbacks, such as fixed financial benefits and high charge rates for households if they exceed the system benefit level. In the case of TOU, the generated tariff by TOU gives high prices on weekday afternoons while it gives low prices otherwise per week. However, the TOU method suffers from one serious limitation, which is the inability to further incentivise to decrease the unnecessary load on specific days, particularly while the system receives the high-stress load. For more efficient pricing response policy, RTP is implemented using hourly tracking of wholesale costs in industrial environments and for domestic customers. Providers and households have different ways of responding to pricing policies.

As far as cost is concerned, customers and suppliers have different levels of awareness of their energy consumption. This is reflected in the time it takes to amend their consumption behaviour. Customers, for instance, usually reflect to their consumption monthly in bills. On the other hand, wholesale and retail suppliers respond to the electricity market with hourly (or even more frequent) changes. Developing accurate time-of-use pricing models is the main focus of many researchers, so they can use accurate price response model (Celebi and Fuller, 2007).

2.2 The optimisation context of power consumption

The next two sections 2.2.1 and 2.2.2 provide an introductory context of the current approaches that allow R-users to make informed decisions regarding their power consumption and help energy providers reduce the peak load demand and reshape the load profile. The former discusses causes of the daily peak times and global statistics, which confirm the challenge increase of power usage in the residential sector. Therefore, optimised R-users' power consumption decisions are necessary to cope with this challenge. Then, the advantages of adopting automatic decision support systems in residential power usage are discussed. The latter then goes on to describe the automatic decision support systems' environment and currently available tools.

2.2.1 Motivations and advantages of power optimisation

Typical energy consumption for a household introduces two peak times over the course of the day. Biological disposition affects rates of metabolism and energy levels over a 24-hour cycle. Most people sleep at night and are awake during the day. External institutions, such as employers, school, and church, demand people's presence at particular times of the day. As a result, if working adults watch television, they are especially likely to do it during the prime-time hours of *8.00-10.00 p.m.* and so on (Harper, 2006). Therefore, electric power consumption varies among different hours in a day, days in a week, or/and seasons in a year. As a result, these consumption patterns might lead to daily peak loads. Recently, electric power demand has reached new peak levels. As a result, new challenges have been applied to balance electricity demand and generation (Sou et al., 2011). The peak-to-average ratio (PAR) is a significant metric that reflects efficient usage of resources, which are allocated for generation, transmission, and distribution. In any electric energy system, the objective of R-users is to minimise the cost while utility objectives are not interested only in the cost but aim to ensure the stability of other parameters, such as load shape, peak time, and quality of service. The balancing between electricity demand and generation could be achieved by minimising the PAR value (Rastegar et al., 2012). The proposed peak minimisation algorithms and

mathematical models would be suitable to this two-tier hierarchical scheme, which could be allocated in the EMS of individual R-users and/or be community-based (Bozchalui et al., 2012; Steinheimer et al., 2013; Yaseen and Ghita, 2017).

In terms of challenges in increasing the energy consumption of the residential and commercial sector, this sector has significantly grown in developed countries and has reached approximately 40% compared with major sectors, such as industry and transportation (Pérez-Lombard et al., 2008). Therefore, more attention is needed to manage the increased energy demand of this sector. As a result, more advantages will be obtained. The U.S. Department of Energy and the European Union Energy Commission both also reported that the energy consumption by the residential customer sector might increase by 20-40% of the overall yearly energy consumption (Yahia and Pradhan, 2018). Moreover, studies in the United States, the Netherlands, and the UK have estimated that 26-36% of in-home energy use is as a result of residents' behaviour (Wood and Newborough, 2003). As a result, the daily peak periods reach high levels in this sector. To respond to the result in demand during these periods, energy providers rely on more expensive power sources which, in turn, lead to more expensive energy costs for customers, as previously discussed in Section 2.1. On account of the price of generated power increasing and the variability of demand, the overall price of energy to the consumer over the course of the day is

proportional to the ratio between peak load and average consumption, this ratio denoted as PAR (Gatsis and Giannakis, 2012; Samadi et al., 2012; Manasseh et al., 2015). In addition to the high power usage of this sector, it is difficult for residential users (R-users) to optimise their consumption manually hour by hour (Du and Lu, 2011; Shin et al., 2017). Therefore, it is an unrealistic scenario to expect that R-users identify the most economical operation of their appliances, according to their lack of required knowledge and time to meet a multiplicity of decision parameters, constraints involved, dynamic tariff prices, peak consumption penalties, and the possible variations of these parameters over time (Sou et al., 2011; Soares et al., 2014). For most economical appliances with power operation scheduling, R-users must both consider current real-time prices and predict appliance usage patterns of the community, as they dynamically change hourly, daily, and/or linked to specific events (Yaseen and Ghita, 2017). As a result, automatic energy management systems are desirable to control the sector's energy consumption.

Concerning the advantages of adopting automatic decision support systems, these systems are highly desirable for controlling the residential shiftable load or, at least, providing advice for better power consumption patterns. Adoption of these automatic systems leads to numerous advantages for energy providers, households, and the environment (Rastegar et al., 2012). For providers, their adoption can reduce peak

load conditions and increase supply reliability. It can also overcome the challenges of dispatch patterns regarding the unit generation problem known as Unit Commitment (UC), which has become a common practice for several decades (Rastegar et al., 2012). UC is applied by either meeting the demand in minimum cost or maximise revenues from energy production. For households, it can reduce energy use during peak times and provide financial savings, increase awareness of energy information, and help households minimise energy wastage during off-peak times. In addition, it helps the household with cost reduction and more convenience could be earned by using an automatic decision system, particularly, by considering residential users' willingness and other R-users' convenience parameters (Yaseen and Ghita, 2019). For the environment, it can save a significant amount of CO₂ emission by using more energy from green or low carbon sources. As such, it can be considered as one of the most cost-effective measures, so far, to address the issues of environment, households, and energy suppliers (Hong, 2009).

2.2.2 Power optimisation environment, and current methods

Instead of traditional power grids, a smart community that composes of a smart grid (SG), smart homes, and home energy management systems (programs) could be used to reduce the daily peak loads (Steinheimer et al., 2015). Smart grids (SGs) offer eco-friendly intelligent power grids for efficient generation, distribution, and

consumption of electric energy (Choi et al., 2012). At the core of the smart grid is the smart home, which describes the automation of connectivity and control of various appliances in the house in one place (Aldrich, 2003; Kushwaha et al., 2004). The adoption of embedded systems on electricity power generators for analysis, control, self-healing, and the bidirectional grid will be more efficient if end-users can adequately respond to the power suppliers' signals (Soares et al., 2014). The problem of R-users' appliance scheduling, known as the residential appliances/load scheduling problem (RLSP), is widely discussed in Yahia and Pradhan, (2018) work. Currently, R-users' appliances are powered in an ad hoc scheduling way by themselves to reduce bills (Tushar et al., 2014). Although some appliances have no scheduling flexibility, other appliances operate better than usual during scheduling operation periods. The introduction of a PAR-aware scheduling strategy can optimally determine the schedule of the appliances, which leads to reducing the amount of imported electricity from neighbouring grids and operation costs. Furthermore, optimal scheduling improves the service availability, stability, and reliability of the grid operations.

Regarding current available automatic decision support systems tools, and because of the growth of demand-side resources such as distributed resources, demand response, and to cope with RLSP problem, energy providers are looking at demand-

side management (DSM), demand response (DR), and energy management system (EMS) services to manage their networks. The utilisation of these services is likely to reduce peak demand and, as a result, reduce the critical grid condition periods, therefore, reducing costs for R-users. These services offer the electricity curtail by R-users, particularly the dynamic DSM, which respond to the real-time or near real-time adjustment of power usage (Setlhaolo and Xia, 2016). DR programs aim to support DSM by balancing the demand to match available energy (Yahia and Pradhan, 2018). DR provides incentives to R-users to shift the power consumption during peak periods into the demand at off-peak periods (Yahia and Pradhan, 2018). To support the end-user energy consumption, the energy management system (EMS) was proposed as a solution to implement optimization algorithms that can manage the power usage of residential users (R-users) (Rasheed et al., 2015; Shin et al., 2017). With respect to DSM, it is the encompassing area for controlling and managing energy consumption on the demand side for minimising the peak load and fluctuation. As part of DSM, prior research highlighted energy management (EMS) and demand response (DR) as integral components. DSM is the general category that refers to the methods that influence the energy consumption of end users. As the demand for electricity varies between consumers, DSM focuses on users' habits (Khan et al., 2015; Ali et al., 2016).

R-users can automatically or manually shift their power usage. However, to provide R-users with a suitable tool for monitoring and directly controlling their own keys, EMSs can be used to automatically and/or manually schedule appliance operation periods (Tsui and Chan, 2012). With regards to EMS, it provides a monitoring and control service with the use of electricity for each household through sensors and/or controllers connected to appliances (Khan et al., 2015; Ali et al., 2016). EMS is composed of a smart meter, a home controller (HC), and distributed agents installed in the home appliances (Rastegar et al., 2012). DR is defined as incentives introduced to electricity users for reducing their power consumption in response to an energy provider's need for electricity as a result of high system demand for electricity or emergencies that could affect the transmission grid (Ali et al., 2016). Further, the incentive payments are designed to induce lower electricity use at times of high wholesale market prices or when system reliability is jeopardised (Albadi and El-Saadany, 2007; Khan et al., 2015).

Another important aspect of currently available automatic decision support systems tools is mathematical modelling optimisation. It is an applied approach to solving RLSP by finding a closed form to the optimal solution (Yahia and Pradhan, 2018). Mixed integer linear programming (MILP) is one of the common strategies used to mathematically formulate and optimise power consumption of R-users and industrial

users (Sou et al., 2011). A classical implementation of MILP was applied in (Meyabadi and Deihimi, 2017). The MILP model provides an efficient and guaranteed solution for particular appliances that depend on environmental factors, such as weather and building structure. Examples of these appliances are heating and ventilation. For more complicated problems, mixed integer non-linear programming (MINLP) is applied to cope with the formulation of appliances with unexpected power usage patterns (Tsui and Chan, 2012). Considering conditions in a real-life scenario, such as convenience, uninterruptible operation, or determining the on/off status of appliances could result in non-linear constraints of the mathematical formulation of solving RLSP (Tsui and Chan, 2012). However, such non-linear formulation would turn into MINLP, which is known as the NP-hard problem, which could increase the complexity and of finding an optimal solution in polynomial time (Yahia and Pradhan, 2018). For these appliances, binary decision variables may be used to determine on/off power operation status and reduce the complexity (Tsui and Chan, 2012). With the problem of considering the above conditions and as realistically as possible, simplified analytical approaches by linear programming (LP) are not sufficient for power optimisation (Sou et al., 2011). To organise the authority of providers to switch off a set of particular appliances while using the formulated binary decision variables, providers could use the direct load

control (DLC) contract framework (Rastegar et al., 2012). The inconvenience resulting from using DLC could be reduced by assuming that providers offer incentives of cheap tariffs for customers, aiming to reduce peak demands.

2.3 Prior work in power usage optimisation and PAR reduction

The related work in this thesis covers three main aspects: energy demand management tools, user satisfaction (willingness) for using these tools, and mathematical modelling approaches to guarantee the optimal solution of these energy demand management tools. As all three aspects overlap for one objective, which is PAR minimisation, some individual studies have used mixed aspects. In this thesis, the related work of the energy demand management tools aspect is widely discussed for PAR minimisation, compared to user satisfaction and mathematical modelling, which could be considered as supplementary tools for energy demand management systems. To present a coherent discussion of the related work in energy demand management tools, three main points are investigated in the previous studies. These points are techniques, PAR results, and load profiles used for evolution in each study.

2.3.1 Energy demand management tools

Energy management approaches refer to the adjustment of demand to match supply. It is the planning, monitoring, and implementation of these utility actions, which are designed to influence customers' electricity usage by introducing various load management approaches. Generally, energy management tools can be split into three categories of solutions for minimising peak load and fluctuations, which are demand-side management (DSM), home energy management (HEMS), and demand response (DR). DSM is the general category that refers to the methods that influence the energy consumption of end users. DSM is mainly practised at the end consumer, as well as on the supplier's side. As the demand for electricity varies from person to person, DSM focuses on the habits of users. In addition, DSM employs energy storage devices, which are helpful for power stations, especially during peak load hours (Khan et al., 2015; Ali et al., 2016; Ullah et al., 2019). HEMS is a system, a whole process, which is implemented in households to monitor and control electricity usage. Normally, HEMS has sensors and/or controllers connected to the appliances. The information collected by sensors is fed to a server or controlling device. Controlling algorithms are implemented to optimise the intake of electricity, so the consumption rate and cost can be reduced. As a result, HEMS allows for controlling the appliances' operation times, alerting and updating users about their

energy usage, reducing the energy costs of a household, and allowing the connected appliances to function properly (Khan et al., 2015; Ali et al., 2016). DR refers to any changes in electric usage by end-use customers from their normal consumption patterns in response to changes in the price of electricity over time. It is noteworthy that this category is considered as a type of DSM (Ali et al., 2016). Further, DR can be also defined as the incentive payments designed to induce lower electricity use at times of high wholesale market prices or when system reliability is jeopardised. DR includes all intentional modifications to consumption patterns of electricity of end-use customers that are intended to alter the timing, level of instantaneous demand, or the total electricity consumption (Albadi and El-Saadany, 2007; Khan et al., 2015). Several studies have investigated using DSM, which aims to strategically engage end-users in energy production and energy storage, shift the energy consumption of shiftable load appliances, and alleviate the use of expensive base loads by generators. As a result, the benefits are applied for both end-users and the utility (Gatsis and Giannakis, 2012; Samadi et al., 2012; Manasseh et al., 2015). From this perspective, Mohsenian-Rad et al. (2010) applied new DSM that scheduled appliances towards reducing PAR using an energy consumption scheduler (ECS). The ECS has functions or additional capabilities assumed to be installed for individual users at the smart meter and connected to network communication by LAN

and a power line. The proposed work evaluation showed that the PAR was minimised from 2.1 to 1.3, and the energy cost was minimised from \$86 to \$53 per day. However, this work evaluation did not use real data—it was merely simulation for a predetermined load with 10 random users and random appliance operation times for 10-20 non-shiftable appliances and 10 -20 shiftable appliances. Nguyen et al. (2012) considered energy storage devices, which are reasonable in the future smart grid beside domestic appliances. A scheduling concept was implemented for charging and discharging the batteries at efficient times. A PAR comparative evaluation of the proposed DSM in different scenarios: without DSM, DSM, DSM with battery, and the centralised management of DSM were concluded. The resulting PARs of this DSM's evaluation were 1.8, 1.6, 1.3, and 1.3 of the scenarios: without DSM, DSM, DSM with battery, and centralised management of DSM, respectively. The evaluation process of the proposed DSM was carried out based on synthetic data by previous research (Paatero and Lund, 2006). In addition to battery utilisation, renewable energy sources (RESs) and distribution generators (DGs) could be used at peak hours to minimise the energy cost of these hours (Gatsis and Giannakis, 2012; Nguyen et al., 2012). Without charging and discharging cycle's scheduler for the storage devices, it is possible for all end-users with storage devices to try

charging their devices at the same time when the energy cost is low. This will result in high peak load at unexpected times.

Manasseh et al. (2015) attempted to overcome these aforementioned issues by experimenting with the integration of the energy scheduler (ES) for the success of the DSM system. They proposed a DSM that uses dispatchable distribution generation (DG), storage devices, and renewable energy sources (RESs) for reduction of the peak load. Although the evaluation process is based on a predetermined load of 1000 random users, 15-25 adjustable appliances, and 15-25 non-adjustable appliances, there are no clear results of PAR minimisation. They claimed, theoretically, to improve the power consumption by proposing DSM that adopted ES, DG, and RES. However, the assumption of non-deterministic, random, or deterministic operation times of devices may not easily map to how each appliance operates. In addition, not all shiftable appliances can be modified to optimise power allocation for each hour. This assumption is suitable for a few devices (e.g., batteries) but most end-user devices do not offer that level of flexibility. On the other hand, several devices do offer flexibility regarding when they are operated. In the same context of supporting R-users with a scheduler controller, Chen et al. (2011) investigated more specific DSM to deal with the shiftable appliances scenario. In this power consumption management, households will rely

on energy management controllers (EMCs), which are devices or programs that use electricity prices and user preferences to modify power usage across a home or building. EMCs schedule power consumption on an appliance-by-appliance basis. Conducting synthetic data evaluations on a neighbourhood of 80 households, it was found that the households alleviated the peak load and reduced the variance between the actual demand and planned supply, where each household had three schedulable appliances. The peak power value of the load profile without energy management was 102.2 kW at 6:50 PM while the proposed DSM scheme had a 28.9% lower peak load of 72.8 kW at the same time.

Another attempt to exploit the advantageous features of particular appliance operation patterns for improving power consumption management was proposed by Liu et al. (2014). They presented another category of appliance called 'throttleable appliances' in addition to shiftable and non-shiftable appliances. These throttleable appliances are defined as appliances that have a fixed operational period but a flexible power consumption pattern, like an air-conditioning unit. DSM management does not aim to change the operation times of throttleable appliances but just predetermine operation periods for operation power demand with tolerant and preferred power. Users would tolerate 26 °C for cooling air conductors; however, they would prefer 24 °C. They proposed a new scheduling scheme for DSM, which

aimed to encourage users to shift some appliances to off-peak hours to reduce PAR. Furthermore, the consumers' own preferred usage requirements were addressed in the energy scheduling algorithm. They assumed residential scheduler (RS) in the system model as a global optimizer after collecting the information from individual smart meters of each household. Examining the feasibility of the proposed system was completed using different DSMs options. These proposed DSM options were centralised DSM, centralised with preferred considerations DSM, distributed DSM with non-preferred considerations, and distributed DSM with preferred considerations. However, their result of PAR reduction in the best case, which was centralised DSM with non-preferred considerations, was not very encouraging as it was 2.1. This is a high value compared with the literature survey so far. The PAR rate of the households' load profile increased to 2.2 with the evaluation using centralised DSM with preferred considerations. The resulting PAR by distributed DSM with non-preferred considerations of the households' load profile was 2.4. However, this value rise to 2.5 with distributed DSM with preferred considerations of households. Table 3 shows the cost varies according to the PAR value.

Table 3 The resulting PAR and daily cost for 10 consumers

Schemes	PAR	Daily cost (dollars)
---------	-----	----------------------

No-scheduling	2.7	63.55
Centralized-Prefer	2.2	42.47
Centralized-Non prefer	2.1	34.05
Distributed-Prefer	2.5	44.39
Distributed-Non Prefer	2.4	38.72

Three studies will be covered in this literature review; they focus on monitoring, controlling, and analysing electrical energy at home, also known as HEMS (Ikegami et al., 2010; Du and Lu, 2011; Bellido-Outeirino et al., 2013). Ikegami et al. (2010) developed an optimal scheduling operation model of domestic electric appliances using mixed integer linear programming (MILP). This model used MILP to minimise the home electricity bill. In addition, it adopted different schedulable appliances such as heat pump water heaters (HPWH), batteries, and hot water storage tanks. Their experiment involved two weeks, 336 hours in each season, which was used to measure data from 1-14 May 2003, 1-14 August 2003, and 1-14 January 2004 in a typical Japanese house. Even though there are no PAR evaluation results in this study, the proposed system reduced the power consumption of HPWH and improved the frequency of the charge and discharge of the battery.

Further study to exploit the advantageous features of appliance operation patterns in HEMS was proposed by Du and Lu (2011). They presented an appliance commitment algorithm that schedules thermostatically controlled appliances (TCAs). This proposed algorithm aimed to find an optimal schedule for each device based on operational constraints and economic considerations. The appliance commitment approach specifies a time-varying temperature range to reflect consumer choices on the appliances' thermostat settings and their perception of comfort constraints. For the evaluation process, the thermostatically controlled electric water heater (EWH) load was used as an example. As a result, the cost was decreased with the temperature limit constraints, as shown in the following Table 4.

Table 4 Energy costs based on power limits

Case	Lower limit	Upper limit	Cost (\$)
1	156	165	0.966
2	147	165	0.862
3	138	165	0.763
4	151	160	0.919

A similar but more complex power consumption study was conducted by Bellido-Outeirino et al. (2013) - HEMS. In addition to the temperature range control, they

enabled automatic power control. In this automatic power control, the appliances are turned on and off without human action according to their control parameters. They implemented light dimming by integrating the DALI (Digital Addressable Lighting Interface) protocol in the developed wireless sensor network (WSN). The DALI protocol is a very simple and easy to build standard. Moreover, it allows for two-way communication, which provides feedback about the status of individual DALI devices. DALI is a well-established standard (IEC 62386) and major electronic ballasts suppliers have adopted it. The proposed HEMS was a combined framework of hardware and software for the power control system. This system evaluated with stochastic data models for the prediction of household consumption. These stochastic data were based on bottom-up models used to generate first the occupation profiles and then the electric consumption for a certain number of houses. There were no peak reduction results of the proposed system.

From a different perspective, DR is a class of DSM programs in which energy providers offer incentives to households to reduce their consumption during peak hours (Khan et al., 2015). These programs were applied under the umbrella of HEMS. Yang et al. (2013) presented a new strategy for pricing between users and energy providers that considered the difference between the nominal demand and the actual consumption. This pricing policy was based on time-of-use (TOU). TOU

is a DR program that gives different price rates. These rates are electricity prices per unit of consumption that differ in different blocks of time per day. The rate during peak periods is higher than the rate during off-peak periods. The simple TOU rate has two time blocks: the peak and the off-peak. They applied game theory by considering a game between energy providers and household to maximise a utility function called GT-TOU. In GT-TOU, the energy provider sets the electricity prices, and the customers respond to the price by adjusting the amount of electricity they use. They applied two factors to maximise the utility function: the cost of fluctuating demands to the energy providers, and the satisfaction costs of users. The peak total load was reduced by 10.24%. They claimed the proposed solution was through DSM programs. This is true to some extent; however, it is clear the proposed solution is a DR program for two reasons. First, the definition of DR is to offer incentives for users, as the proposed research achieved. Second, there is no power management in the proposed solution.

The lack of knowledge among the households about how to respond to time-varying prices and the lack of effective home automation systems are two major barriers to fully utilising the benefits of DR pricing programs. These issues could be overcome using DR pricing programs with a controller. Real-time pricing (RTP) is another class of DR program in which households are charged hourly fluctuating prices reflecting

the real cost of electricity in the wholesale market. RTP customers are informed about the prices on a day-ahead or hour-ahead basis. Many economists are convinced RTP programs are the most direct and efficient DR programs (Albadi and El-Saadany, 2008). One early study that considers employing RTP for the scheduling scheme of power load was proposed by Mohsenian-Rad and Leon-Garcia (2010). They suggested a scheduling unit to achieve home automation systems. This scheduling unit distinguishes the interruptible and uninterruptible residential load, avoids concentration of all appliances in low price hours, and changes the provided power to multiple retailers of electricity. The proposed work evaluation was carried out using synthetic load data with several appliances, varying from 10 to 25 for each household involving single and multiple household scenarios. However, the cost-benefit evaluation of the proposed system was based on real data from the Illinois Power Company from January 2007 to December 2009. As a result, it accomplished performance of below 38% PAR from 4.49 to 2.75 in the single-user scenario and, in contrast, a 22% reduction in the multiple-user scenario. In addition, the electricity cost was reduced by 25% from 108 cents to 81 cents. However, the functionalities and integration details of the scheduler unit with the home automation management system was not clear.

Another attempt to use the DR programs for reducing the peak load of households was proposed by ImranKhan and Saleem (2015). They presented a new DR management that integrated plug-in electrical vehicles and distributed generators. Their proposal used EMC and AMI to unravel the high load shifting to off-peak time and respond to TOU in parallel. They applied ADMM to solve the peak problem formulation. ADMM is an algorithm that solves convex optimisation problems by breaking them into smaller pieces. The proposed management model was run on consistent random bottom load demand based on the MISO daily report by the U.S. Federal regulative Commission (FERC). This random data composed of one electricity provider, 120 households, 30 households, each with distributed wind generators and plug-in electric vehicles, 20 households with solely distributed generators, 30 households with solely plug-in electric vehicles, and 40 households with none of those. From a cost-reduction standpoint, it was declared there was a cost reduction in the daily bill from \$689 to \$521 while the peak value standpoint was only considered theoretically. These pricing incentive programs did not take into consideration the users' preferences and comfort.

Khadgi et al. (2015) proposed a new DR program that provided households with convenient use of appliances in addition to cost reduction using a multi-attribute utility function. The latter function was installed as an independent agent for each

household that enabled a trade-off between the cost and convenience. They suggested that each agent update the scheduling of appliance usage based on maximising the utility function. With regard to the proposed work simulation, they divide the population of households into three categories: high-, medium-, and low-income households. They assumed that high-income households' value has the convenience factor more than cost, whereas low-income households' value has the cost factor more than convenience. They used an object-oriented simulation tool called SIMO to implement these different types of power consumption patterns of households. This tool provides various objects to represent physical or human components of a system and the interactions among them. Its evaluation was simulated using not real data involving 100 participants who measured their power consumption energy over 48 hours, whereby each agent responded to three different types of pricing policies for avoiding simultaneously shifting appliances. These three different pricing policies were the flat model, with one price all day; the abrupt TOU, with three pricing slots per day; and gradual TOU, which has more intermediate slots. The resulting PARs of the power consumption based on responding to these different price policies by the proposed agent were 1.442, 1.353, and 1.349 for the flat rate, gradual TOU, and abrupt TOU prices, respectively. Another PAR result aimed at merely reducing cost was 1.339, which was the lowest result of PAR because it did

not consider the households' convenience. However, the proposed work did not adopt interaction between users, which is the main aim of the agent concept. In addition, the suggested assumptions have several impractical cases, such as the convenient time being uniform from 8 pm to 10 pm, the scheduling running once per day, and solely one appliance running at a time.

2.3.2 Users' willingness for using energy demand management tools

Considering a comfortable lifestyle while balancing energy supply and demand has a significant impact on the performance of home energy management systems, as using personal comfort needs in evaluating energy management systems provides a more realistic scenario of these systems and typical R-users. Every R-user has various preferences, appliances, comfort levels, and willingness to save energy, such as cost and/or environmentally friendly conditions, and so on. The term for R-users' willingness to save on costs by using an automated energy management system could be used interchangeably with comfort (convenience) and defined as 1-comfort (convenience). To consider previous research studies about the user satisfaction (connivance) aspect, Lundén et al. (2013) formulated a prediction algorithm to expect only uncertainty of a non-adjustable load. However, predicting the adjustable load plays a vital role in any demand-side management. Regarding the rare discussion of users' preferences, there are various ways to ensure users'

49

satisfaction (preferences). Du and Lu (2011) proposed a thermostatic algorithm to adjust the temperature of appliances for users' comfort. The waiting time for using appliances was considered the comfort factor and was formulated by Mohsenian-Rad and Leon-Garcia, (2010). While an extension to reduce appliances' maximum power limit was suggested by Gatsis and Giannakis (2012), some appliances, such as air conditioning appliances, are allowed to minimise their maximum load and still satisfy conditions while users dissatisfaction is measured by the distance between the optimised operation power load and the nominal point. In addition to the waiting time and power limit factors, Liu et al. (2014) attempted to minimise the cost then demonstrated a formula that minimizes the users' dissatisfaction.

To produce a practical solution for optimising power usage, user satisfaction needs to be considered in the wider context of user willingness. Concerning user willingness, every R-user has various preferences, appliances, comfort levels, willingness to save energy, such as cost or/and environmentally friendly conditions, and so on. Liu et al. (2014) highlighted the fact that different users having different preferences is still an open issue. Khadgi et al. (2015) argued that many end-users prefer to use electricity even during expensive periods. Therefore, they suggested an agent-based system (ABS) for managing each individual user's needs depending on whether they have a high-, medium-, or low-income. This ABS is responsible for

maximising the utility function, which is computed by a trade-off between cost and convenience. The convenience factor was assumed as fixed hours of power usage during evening and morning times. Similarly, Zhu et al. (2011) applied the concept of fixed hours as users' preferences, then formulated a new user's preferences model but with more details of individual appliances. A manual response of users to satisfy their willingness and optimise the power usage could lead to shifting the load from a typical peak time slot to a non-peak time slot without optimising the power load (Mohsenian-Rad et al., 2010b; Soares et al., 2014; Shin et al., 2017). Mohsenian-Rad et al., (2010b) proposed an energy consumption scheduler (ECS) that gives incentives for users to find an optimal energy consumption schedule. The significant impact of users' willingness for designing a more efficient power usage management system had been studied by Soares et al. (2014). The latter analysed the balance between EMS optimisation levels and users' willingness to accept an automated system to control the power consumption of individual appliances. Recently, Shin et al. (2017) proposed an appliance scheduling methodology for EMS by considering the discomfort index. The basic concept behind their proposal was a numerical correlation between power usage times, which could be measured using the copula-based model. However, applying the numerical correlation between the usage times could not reflect the actual value of users' comfort. For instance, there

is a different convenience level for R-users between shifting the fridge and washing machine even if they have the same numerical measurements of power usage. Even though both appliances have the same convenience level based on numerical measurements for an R-user, this, perhaps, is not applied to another R- user. Each user has an individual level of willingness and comfort factors vary between users.

2.3.3 Mathematical modelling approaches

Mathematical modelling approaches aim to identify the optimal solution of energy demand scheduling for a household. The area of peak-to-average minimization using mathematical modelling received considerable attention in recent years by reason of its cost reduction of energy generation resources, and consequently, R-users' bills. Mathematical modelling approaches are also used for considering real-time modelling aspects, such as modelling comfort, and renewable energy resources used by R-users. Minchala-Avila et al. (2015) classified the optimisation models into classic and non-classic. The classic models deal with linear time-invariant single-input single-output systems while non-classic models deal with nonlinear load profile issues of power consumption. One example of a classic optimisation model is linear programming (LP). In Liu et al., 2014; Mohsenian-Rad et al., (2010b), the authors illustrated how LP could effectively be used to reduce PAR in a centralised manner using the interior point method (IPM) or simplex method. For adding more controlling

52

options in individual households, in Mohsenian-Rad et al., (2010b), the authors extended their work by adding distributed control in individual R-users with an aim of reducing the amount of information exchange between R-users and the energy source. To reduce R-users' dissatisfaction, Daryanian et al. (1989) discussed applying the LP to enable a flexible R-user response without service curtailments. As a result, the power optimisation should be formulated based on multiple objectives, such as variation of demand for household appliances, as well as power generation. Therefore, MILP could be used to combine multi-objectives for power optimisation, such as demand diversity of appliances, solar photovoltaic (PV) panels, and energy storage/generation devices, while considering end-user preferences that result in Mixed Integer Linear Programming (MILP) optimization problems, as proposed by Bozchalui et al. (2012). Tushar et al. (2014) applied MILP for scheduling both the R-users' power consumption and generation. This power generation was integrated into multiple resources, i.e., renewable energy sources and electrical vehicles (EVs). Concerning more conventional objectives and constraints of LP, which are integrated into DSM, Esther and Kumar (2016) reviewed several optimisation techniques in DSM. Consequently, modelling a variety of objectives in energy management systems using MILP provides a clear formula to implement these systems.

Considering real-time modelling implementations, such as modelling comfort, PV, type of load, which includes both continuous (e.g., storage output) and discrete (e.g., on/off states of distributed generators (DGs), and shiftable loads) decision variables, these variables are challenged to be predicted, which results in the solution space of the related optimization problem being nonconvex (non-linear). As a result, classical mathematical programming techniques may not be directly applied (Parisio and Glielmo, 2011). Another reason for nonlinear modelling is considering a comfort factor in a realistic lifestyle as discussed by Anvari-Moghaddam et al. (2015), as it is non-predictable, depending on individual R-users' preferences. Most typical appliances can be easily added to convex programming (CP) when these appliances depend on environmental conditions (predicted or linear conditions), for example, heating and air conditioning. However, adding appliances with binary decision variables, which are required to determine the on/off status of the appliances produced MINLP, which is known to be NP-hard, and is generally difficult to solve (Tsui and Chan, 2012). The nonlinearity issue might also be raised by the uninterruptible operation set of constraints (Setlhaolo and Xia, 2016; Yahia and Pradhan, 2018). As these on/off switching vectors are not predictable during the course of a day, particularly with short resolution time slots in contingent decisions,

nonlinear programming is used to optimize the shiftable load of appliances in on/off states.

In this context, several previous research studies use non-linear models to optimise R-users' power consumption. Tsui and Chan (2012) proposed a framework of EMSs, which was concerned with handling shiftable appliances by on/off status and modelling, which was relaxed in the MINLP. Taking into account resources' cost changes, Marzband et al. (2013) proposed a new MINLP incorporated with EMS to reduce the total cost of energy while considering the local energy market. The proposed MINLP by Marzband et al. (2013) was evaluated by a real microgrid including renewable energy resources. Setlhaolo and Xia (2016) proposed an MINLP model, which considers residential resource management of multiple households linked with a photovoltaic solar energy PV battery system under time-differentiated electricity prices. The nonlinearity modelling might result in complexity to obtain optimal scheduling (Yahia and Pradhan, 2018). Hence, to indicate on/off status of appliances and to reduce the complexity of nonlinear modelling, auxiliary binary decision variables were used.

Auxiliary binary decision variables are commonly used by Rastegar et al. (2012), Tsui and Chan (2012), Tushar et al. (2014), Esther and Kumar (2016), Setlhaolo and Xia (2016), and Yahia and Pradhan (2018). Tushar et al. (2014) used a binary

decision variable only to refer the start time of particular appliances. Tsui and Chan (2012) applied a binary decision variable for shiftable appliances. Rastegar et al. (2012) applied this type of variable to appliances, charging/discharging battery cycles, and plug-in hybrid electric vehicles. In a wider context of using binary decision variables, Yahia and Pradhan (2018) applied this type of variable for both finding optimal/new on/off status for appliances and defining users' preferences of appliances at each given time.

Nevertheless, although optimisation models were proposed by past studies, there is a need to extend them to include more attention in operation times modelling at the appliance-by-appliance level, adequate regularisation for meter readings in real load profiles to satisfy modelling purposes, modelling R-users' interaction in a community, PAR evaluation for R-users in single and community-based scenarios, utilising real-time load profiles of short time slot granularities in mathematical models evaluation, and one framework to include all of the above extensions. All these extensions are to provide better results by more holistic optimisation models.

2.4 Related work discussion and conclusion

The results of the survey have shown an ability to reduce the peak load of households' power consumption by power consumption management. Without requiring eliminating the total daily demand of power by the households, it is possible

to merely shift the operation times of shiftable appliances from peak time to non-peak times. This goal ought to be overcome by scheduling the households' power consumption. Studies have found that various demand-side management (DSM) programmes have been investigated, including energy management systems (EMSs) only, demand response (DR) programs only, and both. However, most studies that improve the interaction of individual households with the community have only been carried out in a small number of topics, as discussed in the prior studies, as such a move towards increasing the power consumption interaction among households in one community may provide the compromise between subscriber convenience and the additional cost reduction they seek. The PAR could be reduced by one community households, as examined by Mohsenian-Rad and Leon-Garcia (2010), who pointed out that increasing the number of users can further balance the aggregated load. Although most of the studies reschedule the operation times of power consumption of households, only a few focus on appliance-by-appliance scheduling, which is an important aspect of power optimisation, as recommended by Chen et al. (2011). The importance of appliance-by-appliance scheduling is more practical and it easily maps the proposed solutions to the real environment. However, it might require more effort for collecting load data and more

complex power management algorithms, particularly with small time slot granularities.

Despite the research towards considering user willingness, there remains a need for an efficient method that performs a variable convenience without setting fixed comfort factors, such as fixed preferred hours for appliance operation times, fixed preferred power for appliances (e.g., air conditioning), and fixed groups of R-users to demonstrate their willingness to use an energy management system based on their income. There is also a need for this variable convenience to be incorporated with two more important aspects: power optimisation methods used historical R-user profiles and a community aspect solution. While individual user preferences were considered in previous studies, the drawback of the fixed convenience of these preferences was inefficient to produce a practical solution. Setting specific preference times for all users, such as suggested by Khadgi et al. (2015), or specific power preferences, such as suggested by Zhu et al., (2011) are far from practical individual user preferences. In addition, clustering users based on their income, as investigated by Khadgi et al. (2015), does not always truly reflect household willingness aspects, because there are users who prefer using energy even at an expensive time. Regarding impractical linear mathematical optimisation methods, these techniques have limitations in handling nonlinear, non-tractable, and

discontinuous functions and constraints. These limitations make the power optimisation problems have nondifferentiability in the results, which often contain sharp points or corners that do not allow for the solution to have a tangent line. This nondifferentiability problem is briefly argued by Mohsenian-Rad and Leon-Garcia (2010), who mentioned the cause of this problem was, for example, the price variation. This causes classical methods to fail. Hence non-smooth problems require a new and nonstandard approach. Gatsis and Giannakis (2012) explained the weakness of considering the objective functions as strictly convex or differentiable. The low performance of game theory in distributed scheduling was benchmarked by Zhu et al. (2011). However, applying energy management systems incorporated with utilising historical data could solve the power optimisation with users' willingness in a high level of practical scenarios. Liu et al. (2014) pointed out the importance of using historical data. Regarding users' willingness in community-based solutions for power optimisation, Lundén et al. (2013) demonstrated that the previous work limitation assumes households have full knowledge of their power consumption (Lundén et al., 2013). For example, the agent suggested by Khadgi et al. (2015) was based on individually optimising single users without any attention to other users' consumption or preferences patterns. However, producing a community-based management solution might achieve the limitations of less knowledge for R-users

about other R-users' consumption patterns. This limitation could be achieved by applying an additional process to a third party, such as a community server. Few researchers have addressed the problem of community-based optimisation of power usage. Zhu et al. (2011) observed the possibility of applying energy management for a neighbourhood/local areas to achieve centralised load management. In addition, Mohsenian-Rad et al. (2010) attempted to develop the community-based solution by adding message exchange between users. However, there is an absence of a community-based solution incorporating users' willingness.

Mathematical model optimisation was proposed in past studies. There is a need to extend such models to include more attention to modelling operation times at the appliance-by-appliance level, producing an adequate regularisation process for meter readings in real load profiles to satisfy modelling purposes, modelling R-users' interaction in a community, evaluating the PAR metric for R-users in single and community-based scenarios, considering real-time load profiles of short time slot granularities, and providing one framework to include all the above extensions. All these extensions are to provide better results by more holistic optimisation models. Finally, with respect to the performance evaluation of energy management systems, many studies never used real data for the evaluation of their proposed optimisation approaches. In addition, the applied random household load profiles were

significantly varied. Therefore, making a comparison among these proposed solutions is implausible. For example, the PAR of the load profile of households applied by Mohsenian-Rad and Leon-Garcia (2010) was 4.49, which is in contrast with the PAR of the load profile of households applied by Nguyen et al. (2012), which was 1.8—both before implementing the proposed solutions. Moreover, the improvement ratio of PAR has mostly little reduction value. For instance, Nguyen et al. (2012) reduced the PAR ratio by 0.2 from 1.8 to 1.6. Therefore, it would be ideal to conduct a robust evaluation, having real data of participants to have more accurate insight into the system.

Given the above environment, three open issues remain to be tackled. First, for power optimisation of DSM in R-users groups, little attention has been paid to expand the model by considering community aspects and appliance-by-appliance to reduce PAR. Second, so far there has been little discussion about end-users that may have different preferences, which could vary based on various factors, such as time of day, real-time price, users' motivation level for environmentally friendly conditions, household income, or lifestyle to name just a few. In this context, it is required to describe and examine the EMS algorithms running in both individual R-users and the community-based DSM to achieve the preferences and controlling requirements. Third, despite the importance of mathematical models, there remains

a paucity of applying mathematical models for community optimisation at the appliance-by-appliance level. For all three aforementioned challenges, little attention was paid to applying real load data to evaluate the proposed systems of PAR reduction. To demonstrate a practical study, real data of power usage for R-users need to be considered at the appliance-by-appliance level with small time slot granularities. Moreover, an appliance-by-appliance level of users' willingness needs to be applied for convenience control.

The chapter highlighted the main components of energy consumption, the optimisation of power consumption for R-users, and the challenges they pose in these communities. Prior solutions were also discussed and the need for developing a more efficient energy optimisation system was determined.

3. Proposed PAR optimisation methods

This chapter introduces a novel energy management system that involves three stages. The first stage is empirical and is based on sequential parsing of load profile data. The second stage is presenting the benefits and limitations after adding R-users' willingness. This willingness presents R-users' acceptance to allow the first stage energy management system automated control of their shiftable power consumption. By considering R-users' willingness, the efficiency of the system was dropped but the wishes of people were considered. The third stage is based on

successfully replacing the first empirical stage with a subjected mathematical model. Four main perspectives are considered to present each new stage: the stage description is presented for stage definition and how each stage is linked to another; the stage environment is presented to describe the stage components and the interactions among these components; the stage algorithm steps are presented to provide the implementation details; and, finally, empirical tests are presented for the algorithm steps to cover real-life conditions in each stage. The main aim of all these three novel stages is PAR minimisation and reducing the power usage fluctuation in residential users.

3.1 Research context and statement

The concept of optimising the scheduling of power consumption in the context of variable energy pricing requires minimisation of the PAR by a novel energy management system. As outlined in the previous chapter, to date, the problem of minimising the PAR of R-users has received little attention in the literature. To avoid undesired power consumption patterns by R-users (i.e., using shiftable load when the energy generators are facing critical time, particularly, at peak hours), new stages are required for a novel energy management system. These stages should describe interactions among domestic appliances, R-users, and a suggested energy management system. The common objective of the new stages in this study is to

minimise the impact of R-users' undesired power consumption patterns' and, as a result, reduce consumption fluctuations by maximising the match between power consumption and generation. This objective is achieved by suggesting a better combination between shiftable and non-shiftable load during the course of a day. This preferred combination is determined by many factors. These factors are the type of load (e.g., shiftable or non-shiftable), appliance-by-appliance analysis (e.g., high or low power usage), R-users' willingness to involve themselves in an automated energy management system, and the proposed energy management system category (e.g., algorithm-based or mathematical modelling-based). Achieving this common objective leads to providing optimal scheduling of appliances' operation times, which improves the R-users' load consumption patterns.

While previous research proposed several PAR minimisation methods to improve power optimisation in the domestic sector, as discussed in 2.2, there is a notable lack of empirical research investigating three main aspects. First, there has been little discussion about community-based solutions, appliance-by-appliance analysis, and real load profiles in previously proposed energy management systems. Second, after proposing a new energy management system, no previous study has investigated users' willingness to allow an automatic system to control their power

usage. Third, suboptimal scheduling patterns to reduce the PAR are obtained by algorithm-based energy management systems depending on how the data load profile is parsed. However, using mathematical models give the optimal scheduling pattern solution. Thus, the aforementioned three aspects for optimising power consumption and its associated problems are not resolved yet, as explained in detail in 2.4. In this chapter, three stages have been proposed to meet these three challenges. First, a new DSM is proposed to optimise power consumption patterns of R-users in single and community-based scenarios. Second, to increase the satisfaction of both sides in terms of cost and convenience, a novel harmonious energy management system between individual R-users' EMS and community-based EMS is described. Finally, a mathematical model used in this study is mixed integer non-linear programming (MINLP), to formulate the optimal scheduling pattern solution.

3.2 A novel demand-side management (DSM) for power optimisation

3.2.1 Introduction

Demand-Side Management (DSM) aims to use a range of methods for rescheduling energy consumption to minimise peak load and fluctuations. To investigate how DSM optimises power consumption patterns of R-users, a new DSM to reduce PAR

and decrease load demand fluctuation has been proposed. This proposed DSM is also based on appliance-by-appliance scheduling. Further, the proposed DSM aims to reschedule the power consumption of one household, taking into consideration the surrounding community consumption patterns.

3.2.2 DSM system environment

The proposed DSM system architecture consists of two types of components, as shown in Figure 5: the household domain component and the community domain component. These entities are responsible for collecting the load profile from users, analysing the data, imposing usage policies, and controlling the appliance operation times based on these decisions. The proposed architecture begins with collecting data using smart appliances, which are defined in the introduction section in Chapter 1. Unfortunately, many of today's appliances, water heating systems, and lighting are not yet equipped with the required sensing, computing, and communication capabilities. These appliances, therefore, cannot participate in the energy management operations without modification but this could be addressed in the short term by plugging these appliances into intelligent power outlets, called smart plugs. Smart plugs are equipped with sensors to measure the energy consumption in near real time and communication capabilities, allowing users to monitor energy usage and apply control remotely (Bouhafs et al., 2014). These appliances connected to a

66

smart controller (gateway) which are responsible also for connecting each house to other houses in one community. A smart gateway is a software application for managing energy-controllable smart appliances that will typically run on a central home server. Several platforms are used to implement smart gateways, such as openHAB and AAL(Britz et al., 2014; Steinheimer et al., 2015). The smart gateway is the core component of the users' domain, which collects consumption of each appliance and controls the shiftable appliances. The gateway may also collect user preferences, such as the required parameters to trade between cost reduction and convenience. In turn, each gateway is connected to the local community server that aggregates and schedules consumption. The proposed DSM system is equipped with two-way communication that enables the system components to exchange information with each other. To achieve this communication among appliances and the gateway, there are several communication protocols, such as KNX, EIB, JSON, or XML and EQ3/Bidcos, or wireless technologies, such as Zigbee, Bluetooth, and so on. For more communication details, see 5.1 (General communication architecture for scheduling methods) section. The smart grid (SG) is another two-way communication technology used to connect R-users with the community server. To avoid undesired power consumption patterns by R-users, defining the type of

operational loads of individual appliances at each given time is crucial. In this study, the operational load types are shiftable and non-shiftable loads.

Regarding optimising the scheduling of power consumption, the operational loads of individual non-shiftable load appliances at each time slot during a day are still the same after optimisation. The T.V is an example of a non-shiftable appliance. In contrast to shiftable load appliances, such as washing machines, the aggregated operational loads of these appliances during a day are still the same after optimisation but the consumption time changes according to PAR minimisation. In this study, these updated operation periods of all appliances are called orders. These orders have the updated optimised scheduling pattern for shiftable appliances for the rest of the day and are periodically updated based on the meter readings. To cope with defining the operational load types, an attached historical database is allocated in the EMS to provide all the technical characteristics of the components (e.g., rated power, storage/production level) and external information includes energy price information, weather forecast, solar radiation, and CO₂ emissions forecasts as an extended work from Bozchalui et al. (2012). It is assumed that the gateway resends the predetermined load profiles of the households to the community domain server. In this study, these profiles are called reports. These reports include intended appliance operational times, in addition to real-time load

profiles. The process is followed by matching the obtained PAR with the desired PAR value determined by providers or based on user preferences. The last step of the proposed architecture process sends the decisions of the new load demand back to the users.

The discussion so far has focused on a single household. Moving from individual, isolated households to a group of users is likely to further improve the power consumption in two ways. First of all, appliance shifting is not individual. The members of the group may take turns shifting appliances and using appliances. The second is that different members of the group may have slightly different peak and off-peak periods as a result of their working and resting patterns. These differences would add more flexibility to scheduling decisions during the course of a day. Therefore, it is expected that optimising the scheduling of power consumption in a community-based solution performs better.

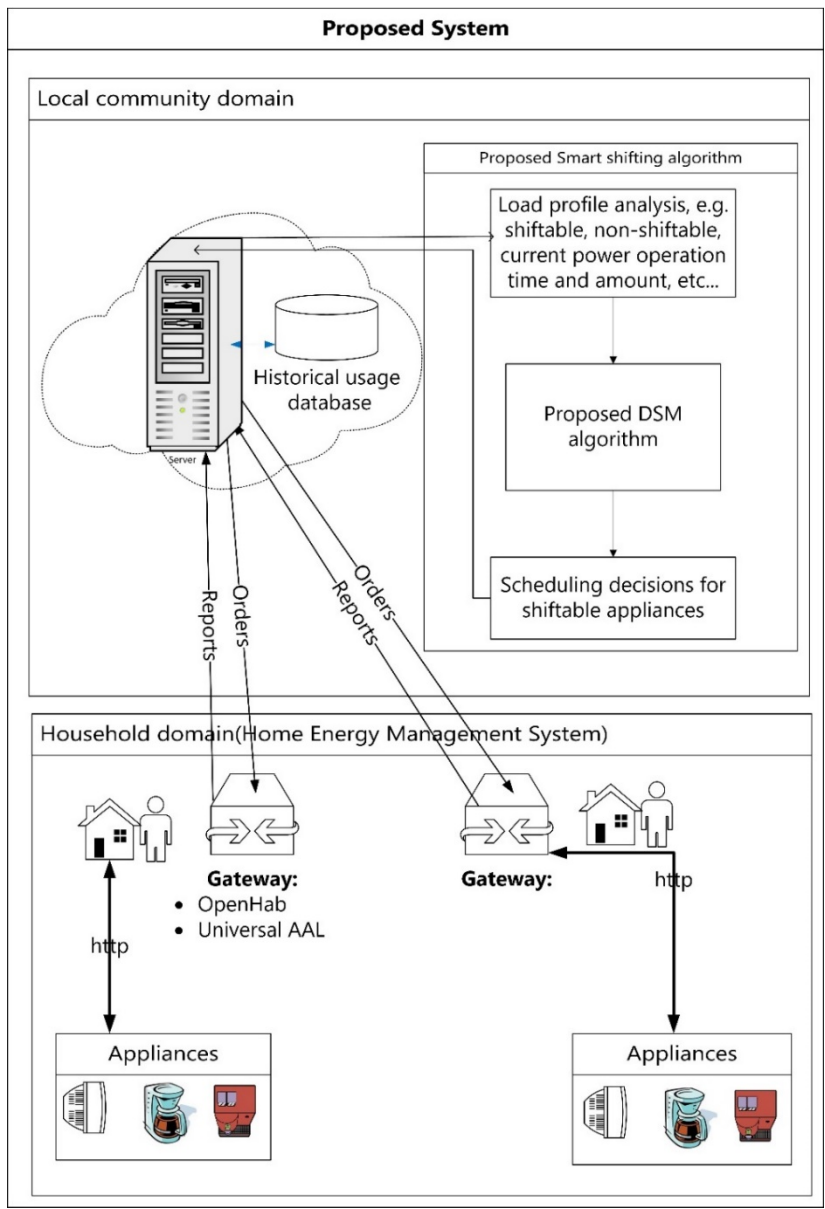

Figure 5 Proposed system for DSM based on community interaction

3.2.3 A novel algorithm in DSM

A primary DSM algorithm has been proposed to reshape R-users' power-usage profiles with the aim of optimising these profiles by reducing PAR. The goal of this algorithm was to reshape the household load profile by rescheduling the shiftable appliances from on-peak to off-peak hours. The rescheduling technique was used by Mohsenian-Rad et al. (2010a), Chen et al. (2011), Nguyen et al. (2012), Liu et al. (2014), and Manasseh et al. (2015). Here, further adjustments were suggested suitably for scheduling the load by power consumption management.

These adjustments are summarised as follows. Figure 8 shows a flowchart for the general implementation of the proposed DSM algorithm, which aids in comprehending the presented smart shifting algorithm used in this study. At first, it is started by *Read load demand*, which includes the real-time meter readings from R-users, as well as historical data of load consumption profiles of R-users. Therefore, the load demand profile is a table that contains appliances' power meter readings in watts and are grouped based on daily time slot resolution, historical power usage data, appliances-id, and R-users-id. The appliances-id and R-users-id are needed for community-based solutions to enable the server to access a specific appliance for a particular R-user. Collecting real-time meter readings begins by turning on daily required appliances in households. These meter readings in the load

profiles are considered the preferred times of using shiftable appliances by R-users during the day. This is the only required input entered by the R-users into the proposed algorithm of DSM. The historical data of load consumption profiles for the R-users is assumed to be already collected, stored, and available to be used by the proposed novel algorithm of this study. A screenshot of the real historical data of load consumption profiles, which are used in this study, is shown in Figure 6.

Appliance \ Time	0:00	0:10	0:20	0:30	0:40	0:50	1:00	1:10	1:20
Cold Appliances	62.4	64.3	64.5	64.5	63.9	62.3	62.5	62.2	62.2
Cooking	7.3	6.9	6.9	6.8	5.9	5.6	5.8	6.1	6.9
Lighting	49.5	45.7	40.3	36.8	33.4	30.7	28.0	26.0	24.7
Audiovisual	51.1	48.6	45.0	42.0	39.2	36.7	34.7	32.9	31.1
ICT	18.7	18.7	18.0	17.2	16.6	16.0	15.5	15.2	14.9
Washing/drying/dishwasher	31.6	32.9	27.7	24.6	24.0	19.5	16.4	14.6	15.2
Water heating	3.2	6.0	9.0	9.7	9.1	9.0	10.3	8.6	6.3
Heating	62.8	63.2	55.0	51.4	33.1	26.7	25.6	34.1	36.0
Other	14.5	14.9	13.8	13.8	14.6	13.8	13.8	13.6	13.9
Unknown	71.6	71.7	69.2	64.7	62.3	63.7	63.1	61.3	60.7
Showers	2.8	1.7	0.7	3.0	2.8	1.4	1.2	0.5	1.3

Figure 6 Historical load demand information watt (W) (Jason Palmer et al., 2013)

Next, the *Initial analysis* step was applied, which can be described using the following steps. Step 1: analyse the appliance-by-appliance level to check the shifting status of individual appliances. Step 2: automatically create and add a new column in the load profile data, which contains shiftable and non-shiftable indicators for all the appliances of all R-users. This column is named the *appliance shifting status*, which contains 0s and 1s referring to the non-shiftable and shiftable status of all appliances, respectively. It is used to respond to any enquiry about shifting the

status of all appliances. The response to each enquiry uses a variable called the *appliance-counter*, which assumes that R-users and novel algorithms identified each appliance based on a specific number stored in the *appliance-counter*. For example, *appliance-counter* = 6 means both the household and the novel algorithm know this appliance is a washing machine, as shown in Figure 7. Step 3: calculate the initial peak and off-peak load and times based on historical load profiles. Identifying these times is useful to turn on the shiftable appliances outside the expected peak times. Step 4: calculate the *Historical_average_load*, which is equal to the average load of the initial peak and off-peak load during the day.

At each time slot in the day (in this study, every 10-minutes), *Read_current_load_demand* applies power usage meter reading for all appliances. A screenshot of a time slot power usage reading is shown in Figure 7. Then, the current total power consumption of all appliances is calculated and stored in the *current_aggregate_load* variable.

Appliance	Time
Appliance	14:50
Cold Appliances	66.0
Cooking	50.1
Lighting	27.3
Audiovisual	66.5
ICT	28.4
Washing/drying/dishwasher	68.5
Water heating	6.2
Heating	18.2
Other	23.4
Unknown	94.4
Showers	6.7

Figure 7 Load demand information at the current time slot in watts (W)

Next, the individual gateway of each household takes responsibility for collecting all the power load data of the appliances in each house. It is noteworthy that all appliances, including traditional, non-smart appliances, can send the power data and receive the control signals to and from the gateway using wireless smart plugin devices. The gateway is responsible for sending the collected power data as a report to a local community domain server. After the local community domain server collects all the required households' power usage data, it checks whether there is a need to reschedule the load or not. It starts rescheduling the intended power usage of households if the *current_aggregate_load > Historical_average_load* condition is met.

Next is rescheduling the shiftable appliances from high load to off-peak times, which were previously determined by applying the *Initial analysis* step. Turning the shiftable appliances on/off is based on basic programmed algorithm steps that run on the local community server, which is described as follows. First is scanning utilization across all appliances at the current time slot under this condition *If appliance_counter < Number_of_all_appliances*. This scanning is useful to identify the shiftable status in the appliance-by-appliance level, which is applied by calling this step *if appliance shifting status [appliance-counter] == shiftable status*. Step 2 is scanning all the time slots to identify the expected time slot with a minimum power usage by the *Find_the_off_peak_time* process. Step 3 is rescheduling the respective shiftable appliances by turning them off/on to the identified minimum power usage time slots using this step *Shifting_load_function*. Step 4 involves updating the load profile for all changes have been made to all shiftable appliances across all the time slots by the *Update_the_load_profile* step.

These operation periods of all appliances result from the algorithm sending back to the gateway of each household the periods previously defined as orders for the purpose of PAR reduction. The gateway of each household is responsible for passing these new operation periods to each individual appliance using the orders

(which were already explained in 3.2.2 and in Figure 5). As a result of the rescheduling, the peak load is decreased. Summing up the process flow of the rescheduling load process starts with analysing the load profile of the R-user and specifying the on-peak and off-peak times. Then it follows by shifting the procedure for shiftable appliances to decrease the peak load demand. The last step is to update the R-user with the new operation times of shiftable appliances using the orders. The comparative evaluation of the algorithm-based load to the original load is then applied by computing the peak load and PAR. This evaluation shows a significantly better performance in using the proposed DSM architecture.

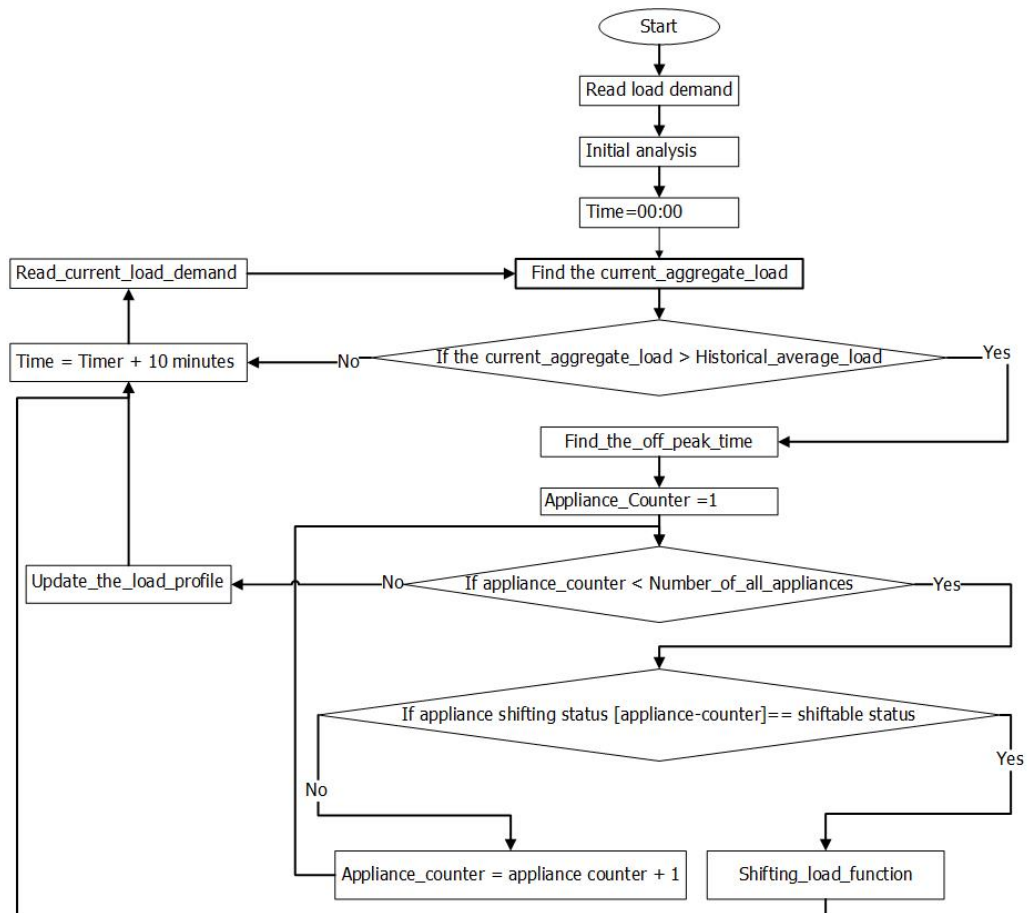

Figure 8 Flow chart of load profile rescheduling

3.2.4 Empirical testing using real-load data profiles

Preliminary experiment tests of the proposed algorithm using a real data set (see Section 3.2.3 for more details on the algorithm), raised the issue of unexpected high load usage of particular appliances operating in houses. When the proposed

algorithm merely shifts a few requests in the problematic appliances category, it rebounds the peak load from one period to another period. Section 4.2 has more experimental details to present the negatively effects of this issue. The issue of the unexpected high load of individual appliances of some R-users means these appliances have significantly high power usage. When the proposed algorithm shifts these appliances, it rebounds the peak into another time slot. This issue of the unexpected high load of individual appliances of some R-users was discussed in a previous study (Jason Palmer et al., 2013), where it was argued that larger households and larger dwellings tend to use more electricity compared with households that have newer appliances, which used less power. This is because some old cold appliances, which may be faulty, use more than three times the average electricity and some households have many more fridges and freezers than average (one of the households surveyed in the study had four cold appliances. To cope with this issue, the authors in the previous study, Jason Palmer et al. (2013), recommended replacing inefficient appliances with the most efficient appliances, as this change had the potential to reduce peak power demand. Although the study highlighted that such households could be targeted in attempts to reduce the base load power use, no energy controlling procedure was suggested. For the three stages of the novel energy management system in this study, proper solutions

according to individual proposed systems have been proposed and tested for potentially shifting unexpected high load shiftable appliances.

Considering appliance-by-appliance control in the proposed algorithm, additional attention has been paid to avoid shifting unexpected high load appliances, as shifting this type of appliance leads to high peak load for a short time. Therefore, updated flowcharts for single R-users and multi-R-users were implemented to overcome the unexpected high load use of appliances by adding predicting process steps before the shifting decisions, as can be seen in Figure 9 and Figure 10. Hence, the proposed procedure was based on using the R-users' historical data to predict the total load of the new slot, which is meant to shift the load to it. If the prediction outcomes say that after shifting, the peak will be rebounded, then it is no longer needed to shift this appliance, even though it is a shiftable appliance running at peak time. The updated flowcharts are evaluated in a number of R-user scenarios, which include single and community-based R-users aspects. To understand the reason behind low/no optimisation for some R-users who have unexpected high load usage appliances, the *Failed_Shifting_Req_counter* was added to the proposed DSM to define the number of attempts made by the proposed algorithm to shift this type of appliance but without implementing the shifting requests. The reason for blocking these shifting requests is that the proposed DSM predicting process concluded that shifting these

requests rebounded the high undesirable load from one time slot to another time slot without optimising the usage pattern. To determine which R-users have this issue, the proposed DSM attached this counter to individual R-users. For more details, see Chapter 4, Table 8. The second predicting step added to the DSM algorithm was *Find_Predicted_Off_peak_time* to allocate the predicted load value of the next off-peak time after the shifting. This is useful for checking the expected usage value before starting the shifting process.

The proposed DSM differs from the related work in the literature by considering several aspects, as follows: a community-based approach where the power consumption of each individual household is rescheduled by taking into consideration the surrounding community consumption patterns. Appliance-by-appliance scheduling is a bottom-up model that can be easily applied to develop new control algorithms and disaggregation of electric consumption (Bellido-Outeirino et al., 2013). Applying real load profile data of households leads to valuable performance evaluation of the proposed system and it can be easily mapped to the real environment.

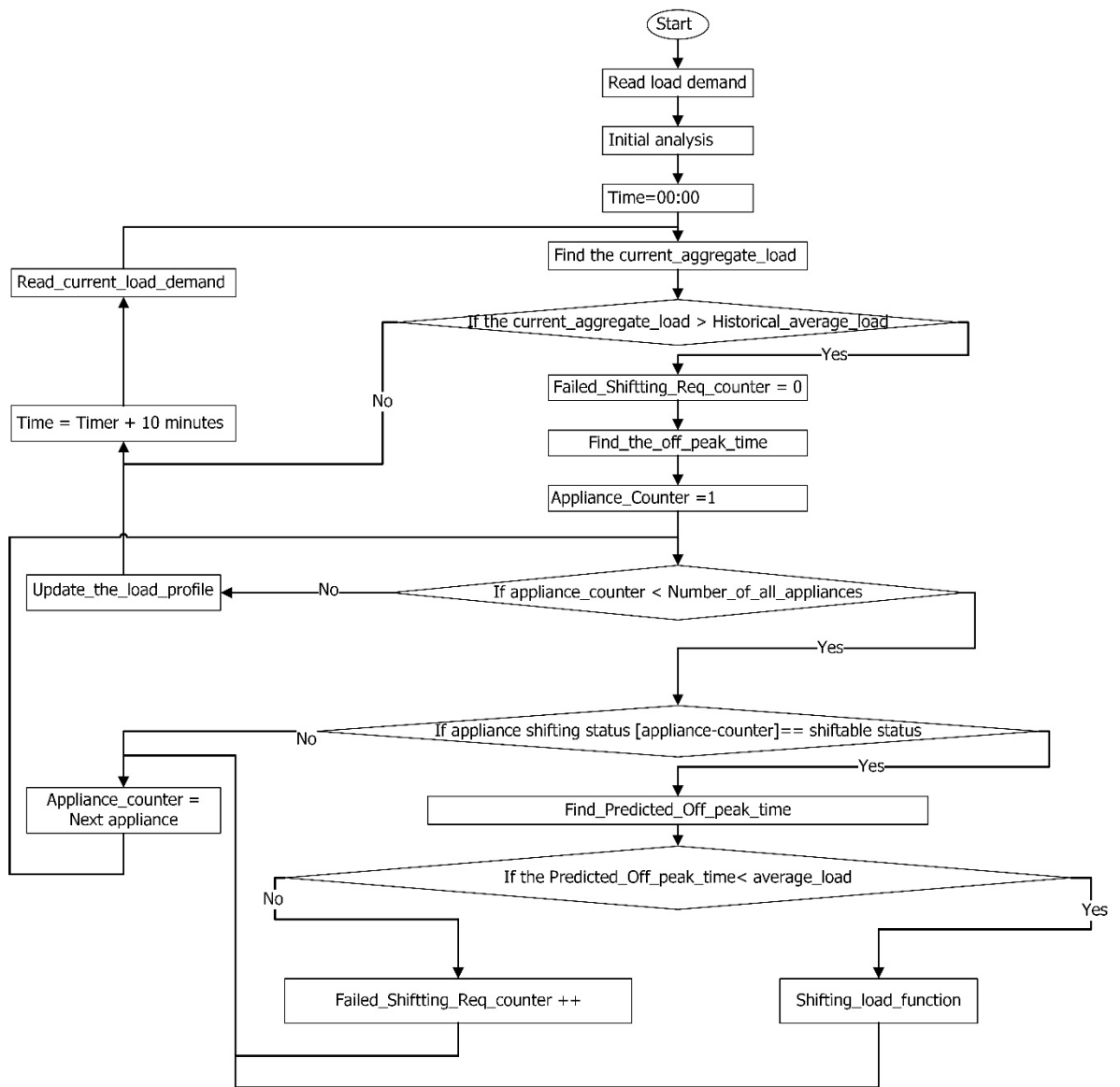

Figure 9 Energy management control program in a single R-user scenario

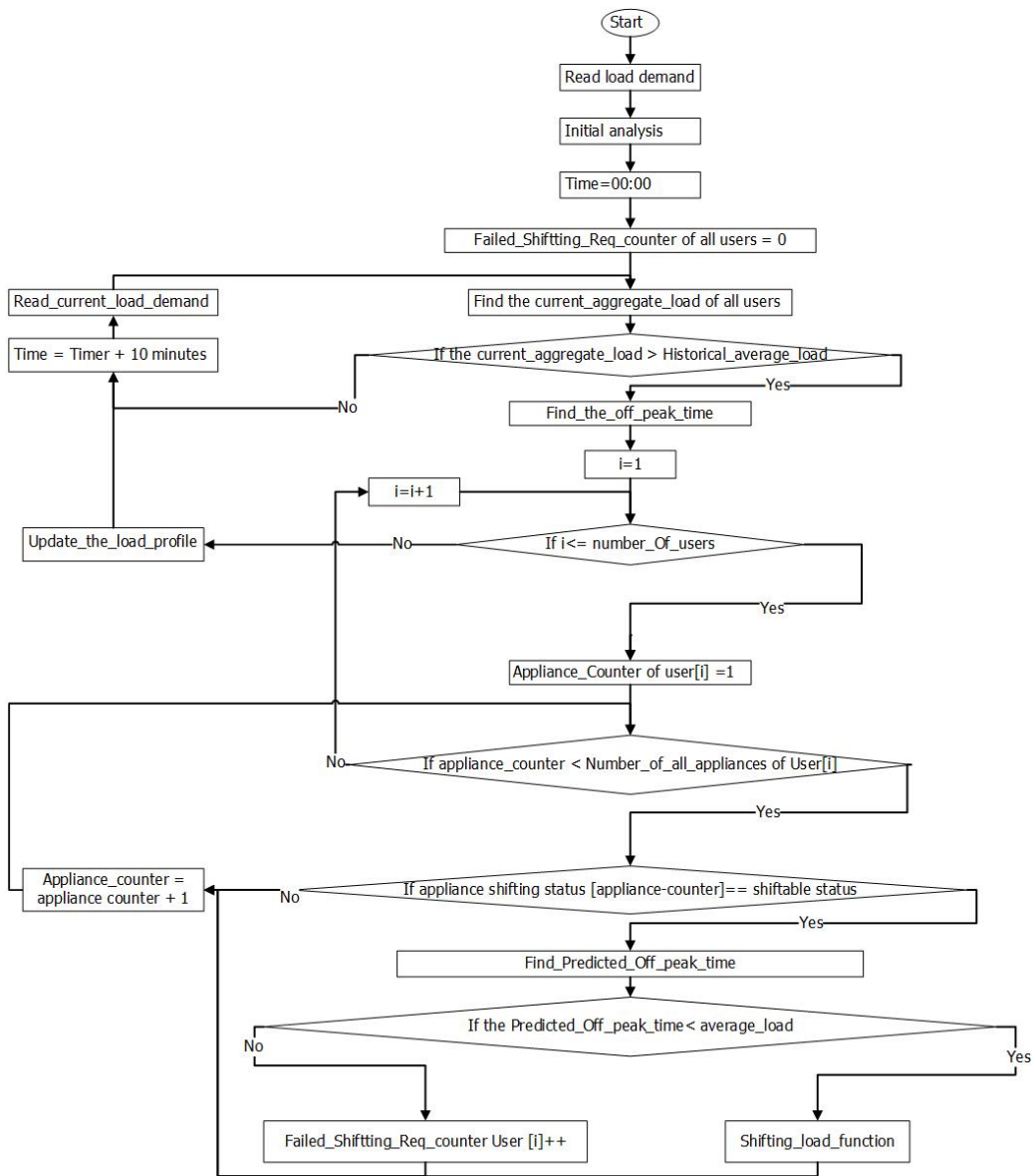

Figure 10 Energy management control program in a multi-R-user scenario

3.3 Willingness-controlled residential energy management system (EMS)

3.3.1 Introduction

As acknowledged by previous research, the issue of PAR and community energy saving are critical in the context of reducing energy costs and the associated impact on energy suppliers. To produce a user willingness-based reflective solution for an energy management system that optimises power usage, R-user satisfaction needs to be considered in a wider context. In terms of R-user willingness, every R-user has various preferences, appliances, comfort, willingness to save energy, such as cost and/or environmentally friendly conditions, and so on. Liu et al. (2014) highlighted that different users having different preferences is still an open issue. Despite the research towards considering users' willingness, there remains a need for an efficient method that conducts variable convenience, practical numerical optimisation methods, and a community aspect solution, as discussed in detail in 2.4. To investigate how the DSM proposed in Section 3.2 performs with different R-users' willingness values, a new stage to reduce the PAR has been proposed.

3.3.2 EMS system environment

To provide the prior proposed DSM, see Section 3.2 for more details on R-users' willingness and the EMS, which is one of the main DSM components. The EMS was already defined and related work was explained in sections 2.2.2 and 2.3, respectively. In addition to the previous DSM environment (for more details, see section 3.2.2), this environment provides harmonious energy management between the R-users' EMS and the community-based EMS, which leads to increasing the satisfaction of both sides in terms of cost and convenience, as shown in Figure 11. This is assuming every user is supported by an EMS, as developed by previous studies (Bellido-Outeirino et al., 2013; Du and Lu, 2011; Ikegami et al., 2010). An EMS is composed of an advanced metering infrastructure (AMI), an energy management controller (EMC), and an in-home display (IHD). The functionality of the EMS in the proposed system components is varied based on either individual R-users or community power usage optimisation. In terms of the functionality of the proposed EMS', each EMS in R-users sends information (operational time slot, consumption rate, maximum and minimum capacity, and shiftable and non-shiftable load at each given time) to a community-based EMS, which determines the optimal scheduling of shiftable load by reordering the operational times of individual shiftable appliances across all communities. This EMS could be used to provide the

community server with users' willingness values at given times. These values reflect the incentive level of the power load optimisation to each user to allow an automatic system to control the users' power usage. These values could be conducted based on several factors, such as time of day and real-time price. The EMS takes the responsibility to send the current willingness values of each user to the community-based server. The updated operation times of the shiftable power consumption are sent back to the EMS of R-users by individual orders, which are sent periodically based on time-slot duration Δt . The individual EMS of R-users implements the orders in each shiftable appliance of the smart home. This process is repeated regularly based on Δt . Briefly, individual EMSs started by sending the reports to the community-based EMS and ended by implementing the orders by the EMS in R-users' appliances.

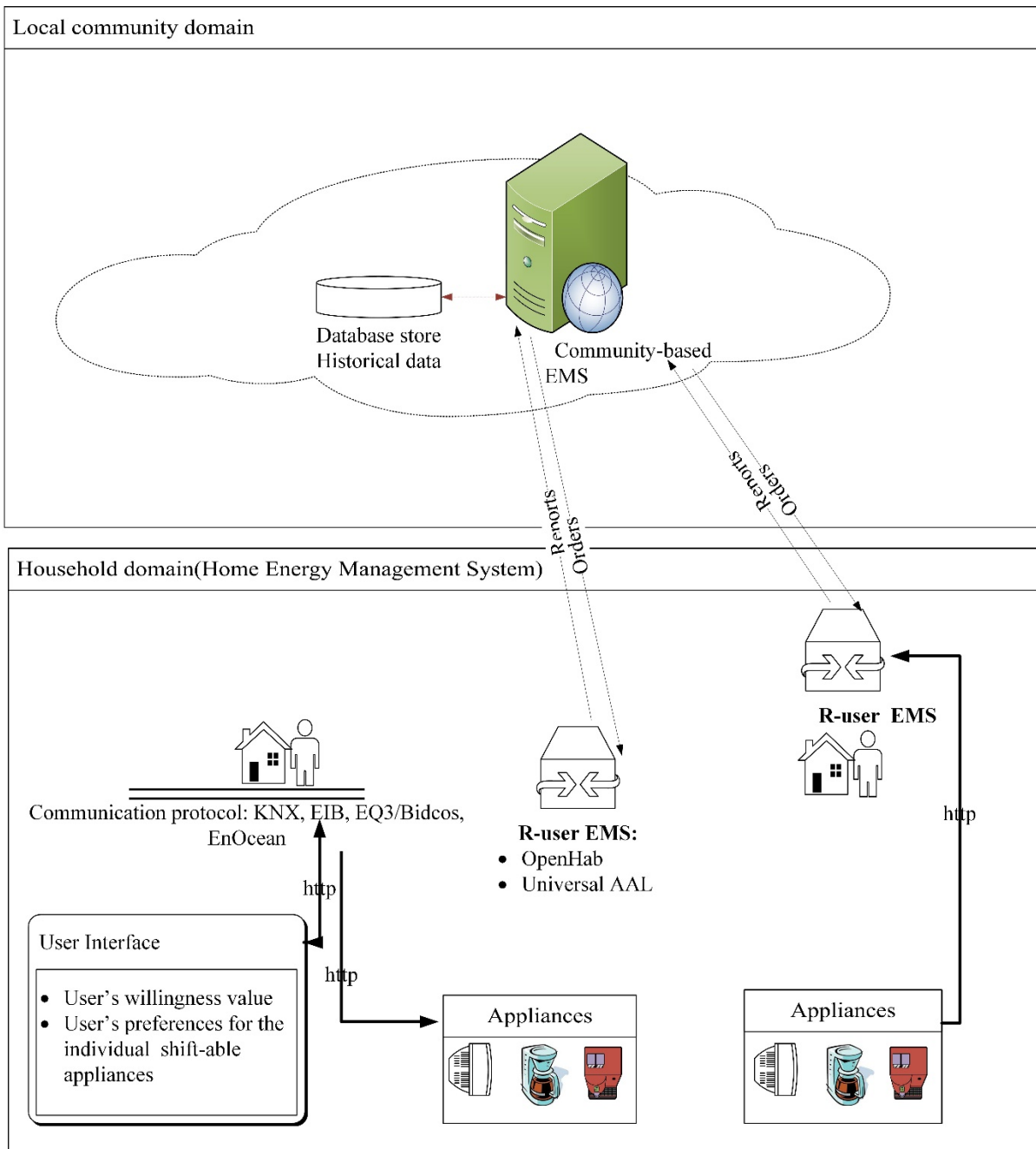

Figure 11 The architecture of the proposed willingness stage

Concerning the practical implementation point of view for the proposed EMS, evaluating the willingness of R-users to utilise the proposed work is vital. In this study, a random willingness value was assigned to each individual R-user. This willingness value represents the acceptance level of the user to allow the proposed EMS to optimise the shiftable load. Households have different preferences during the day. For example, one household prefers shifting the washing machine over the dish dryer in the morning while the same user prefers the opposite at night. This willingness value impacts also the R-users' preferences for choosing to vary shiftable appliances. In this study, a variance of these preferences has been considered in a 10-minute resolution which, in turn, gives R-users free choices to change their preferences at each given time. This is applied by the *Receiving_R-user_preferences* step, as seen in Figure 12. With this, the user still needs to decide the preferred shifting appliances based on his/her willingness, which is governed by a number of allowed requests *N-allowed_Req* requests. A variety of preferences is considered at 10 minutes resolution. Evaluating the R-users with willingness in both scenarios, in a single-user scenario and in a multi-user scenario, played a key role in measuring the effectiveness of the proposed work.

Concerning general user load types, each user has shiftable and non-shiftable loads depending on their appliance types. The willingness value by individual EMSs will

influence only the shiftable load while the non-shiftable load patterns of all users will have no effect by the proposed load-controlling algorithm. For example, if there are three users, user-1, user-2, and user-3 with willingness values 0, 1, and 0.7, respectively, it means user-1 has no willingness. Therefore, there is no allowance for the community server to influence any load for this user. User-2 allows the community server to fully control all the shiftable loads when there is a high power usage at each time of day. User-3 with willingness 0.7 means the user allows only 0.7 of his/her shiftable load to be controlled by the community server. It is noteworthy to mention that, in addition to each user having different a willingness value, the individual user's response, from a practical perspective, is different depending on their comfort level linked to each individual appliance. For instance, although two users have the same willingness values, for example, 0.5, which means the community server has affected only half of the shiftable load of each appliance, each user might choose different shiftable appliances. For example, one user may prefer shifting the dryer machine and the washing machine while another prefers shifting the dishwasher and air conditioner. To counteract this, the following section describes a novel controlling algorithm.

3.3.3 A novel algorithm in EMS

The proposed algorithm that runs in the community server considers the effect of the willingness values on an appliance-by-appliance level of individual users. Furthermore, the shiftable appliances preference of individual users might vary from one time to another. For example, the users' preferences vary between working days and weekends or between summer and winter. To adopt these willingness conditions into the proposed energy management system, several procedures were added. The flowchart of multi-R-users with willingness is presented in Figure 12. In this flowchart, the total number of shifting requests at each time slot was calculated by *Find N-SHF-Req*. It can also be seen that the added procedures were implemented to achieve the willingness concept, such as checking the willingness values of individual R-users, finding and storing a number of allowed requests for individual R-users based on their willingness at each given time in the *N-Allowed-Req* parameter, etc. By applying Receiving R-users' willingness, users were asked to provide the model with the willingness values. These values are random values provided by users and were classified into three intervals- $[0.8,1]$, $[0.3,0.7]$, and $[0.0,0.2]$. The highest value meant the user was highly willing to optimise power consumption and vice versa.

Therefore, satisfying information exchange between the HEMS and the community server is crucial to find optimal scheduling of the load, which reduces PAR with

response to R-users' willingness values. This information exchange could be obtained by the following steps: EMSs of individual users periodically update the community server with the current load. The community server decides whether or not there is a need for load shifting at each time slot in a day. If there is a need for shifting, the community server asks the EMS for the user's willingness and preferences for an appliance at the appliance level. The community server finds the optimal scheduling that reduces the PAR with respect to users' willingness and the appliance-by-appliance level. Next is updating all EMS' of users with the new optimal scheduling. To obtain the optimal scheduling, whilst considering user satisfaction, the following Pseudo code 1 was proposed:

Pseudo code 1 the optimal scheduling with considering the user satisfaction

Let N be users, M_n number of appliances for n user, s_n shiftable appliances for n user, i_n essential appliances for n users, $x_{n,s}$ scheduling vector for shiftable appliances, $x_{n,e}$ consumption scheduling vector for non-shiftable appliances, t given time, $t \geq 00:00$, and $t \leq T$, $T = 23:50$, ct current time slot, $Dataset_Hist$ historical data set, $Dataset_Updated$ optimized power usage dataset, W_n willingness value of user n , Na_SHF_Req number of shifting requests, $Na_allowed_Req$ number of allowed shifting requests based on the willingness value, and $Apply_SHF_List$ be the list of selected shiftable appliances the user chose to be shifted.

Initialise parameters (W_n , $Agg_Load_t = \sum_{n=1}^n l_n^t$, while $l_n^t \triangleq \sum_{i,s \in M} x_{n,i}^t + x_{n,s}^t$,
 $AVL_Hist = \text{mean}(\sum_t^T (Agg_Load_t))$), WHILE l_n^t used in AVL_Hist based on $Dataset_Hist$.
REPEAT
 IF ($Agg_Load_{ct} > AVL_Hist$)
 THEN
 // the Agg_Load_j calculated by $Dataset_Updated$
 $Offpeak_val = Agg_Load_{ct}$
 FOR ($j = ct, j < T, j++$)
 IF ($Agg_Load_j < Offpeak_val$)
 THEN
 $Offpeak_val = Agg_Load_j$
 $Offpeak_slot = j$
 ENDIF
 ENDFOR
 FOR ($n = 1, n < N, n++$)
 IF ($W_n > 0$)
 THEN
 $Na_SHF_Req = \text{length}(x_{n,s}^{ct})$ // for each $[x_{n,s}^{ct}] > 0$
 $Na_allowed_Req = W_n * Na_SHF_Req$
 $Apply_SHF_List = \text{Random.Select}(x_{n,s}^{ct}, Na_allowed_Req)$
 FOR ($k = 1, k < Na_allowed_Req, k++$)
 $Predicted_Agg_Load$
 = $Agg_Load_{offpeak_slot}$
 + $Apply_SHF_List[k]$
 IF ($Predicted_Agg_Load < AVL_Hist$)
 THEN
 Dataset Updated [
 $Apply_SHF_List[k].row, offpeak_slot$] =
 Dataset Updated [
 $Apply_SHF_List[k].row, offpeak_slot$] +
 Dataset Updated
 [$Apply_SHF_List[k].row, ct$]
 Dataset Updated
 [$Apply_SHF_List[k].row, ct$] = 0
 ELSE
 $Offpeak_val = Agg_Load_{ct}$
 // find another possible off peak
 FOR ($j = ct, j < T, j++$)
 IF ($Agg_Load_j < Offpeak_val$)
 THEN
 $Offpeak_val = Agg_Load_j$
 $Offpeak_slot = j$

```

                                ENDIF
                            ENDFOR
                        IF (Predicted_Agg_Load < AVL_Hist )
                        THEN
                            Dataset Updated[
                                Apply_SHF_List[k].row, offpeak_slot] =
                                Dataset Updated[
                                Apply_SHF_List[k].row, offpeak_slot]+
                                Dataset Updated
                                [Apply_SHF_List[k].row, ct]
                                Dataset Updated
                                [Apply_SHF_List[k].row, ct] = 0
                        ELSE
                            Unresponse_SHF_Req++
                        ENDIF
                    ENDFOR
                ENDFOR
            ENDFOR
UNTIL (Agg_Loadt) = ∅ // there is no load by users

```

3.3.4 Empirical testing using real-load data profiles

The unexpected high load appliances issue, which was described in 3.2.4, had a negative impact on the willingness-based stage. This negative impact resulted from high power usage of appliances and the fact that R-users were occasionally willing to keep them on for a long time. Therefore, there were two main reasons for the drop in optimising the scheduling of power consumption. First, households might not have been willing to shift the appliances that did not have any issues and, second, the optimisation system may have prevented shifting the appliances that did have issues. As a result, the optimisation significantly dropped.

Therefore, considering R-users' willingness increases the probability of not applying the load shifting of high load appliances. Figure 13 presents the power usage of two

R-users who have this kind of appliance before applying a controlling procedure that handles this challenge.

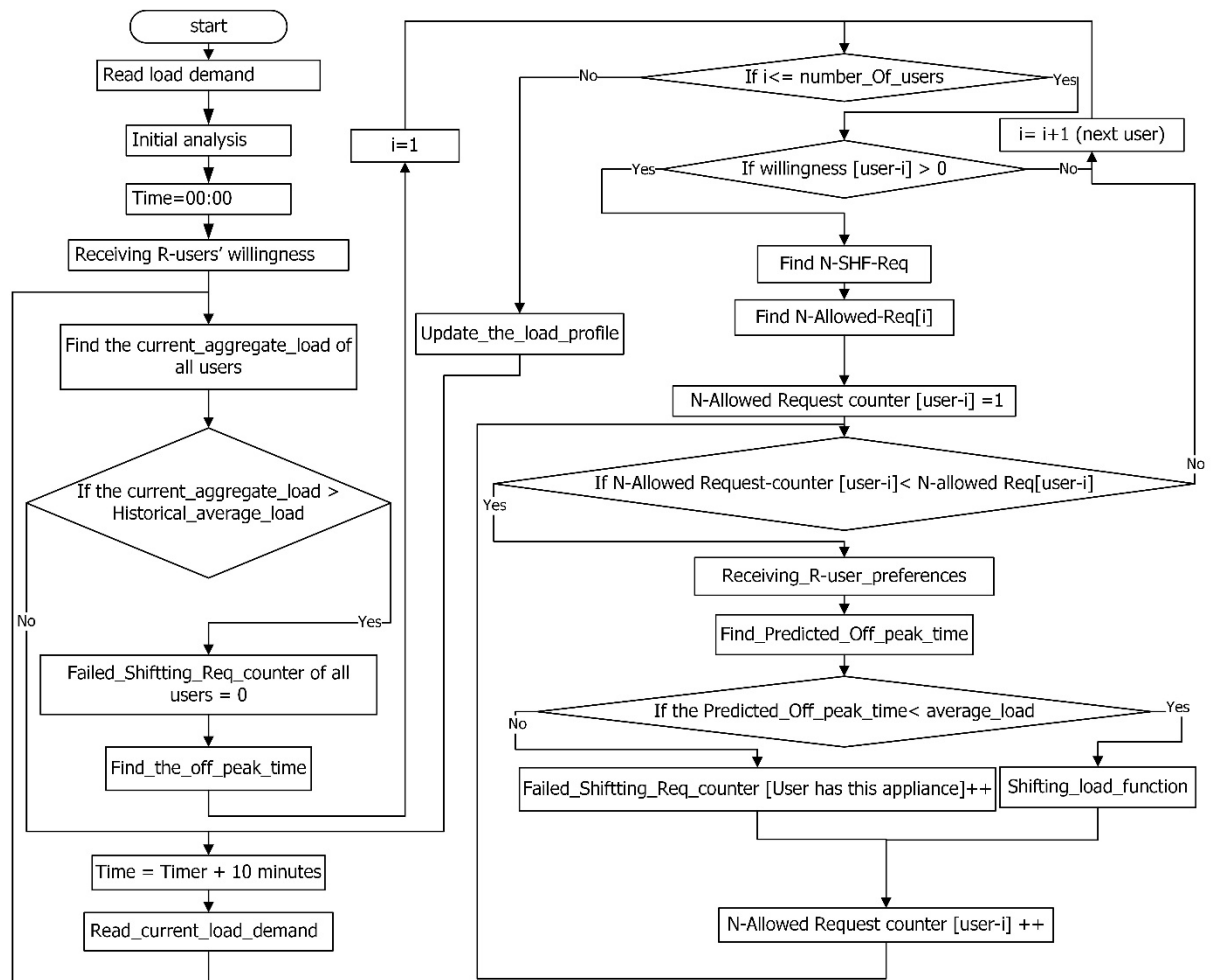

Figure 12 Energy management controlling flowchart for multiple users with users' willingness scenario

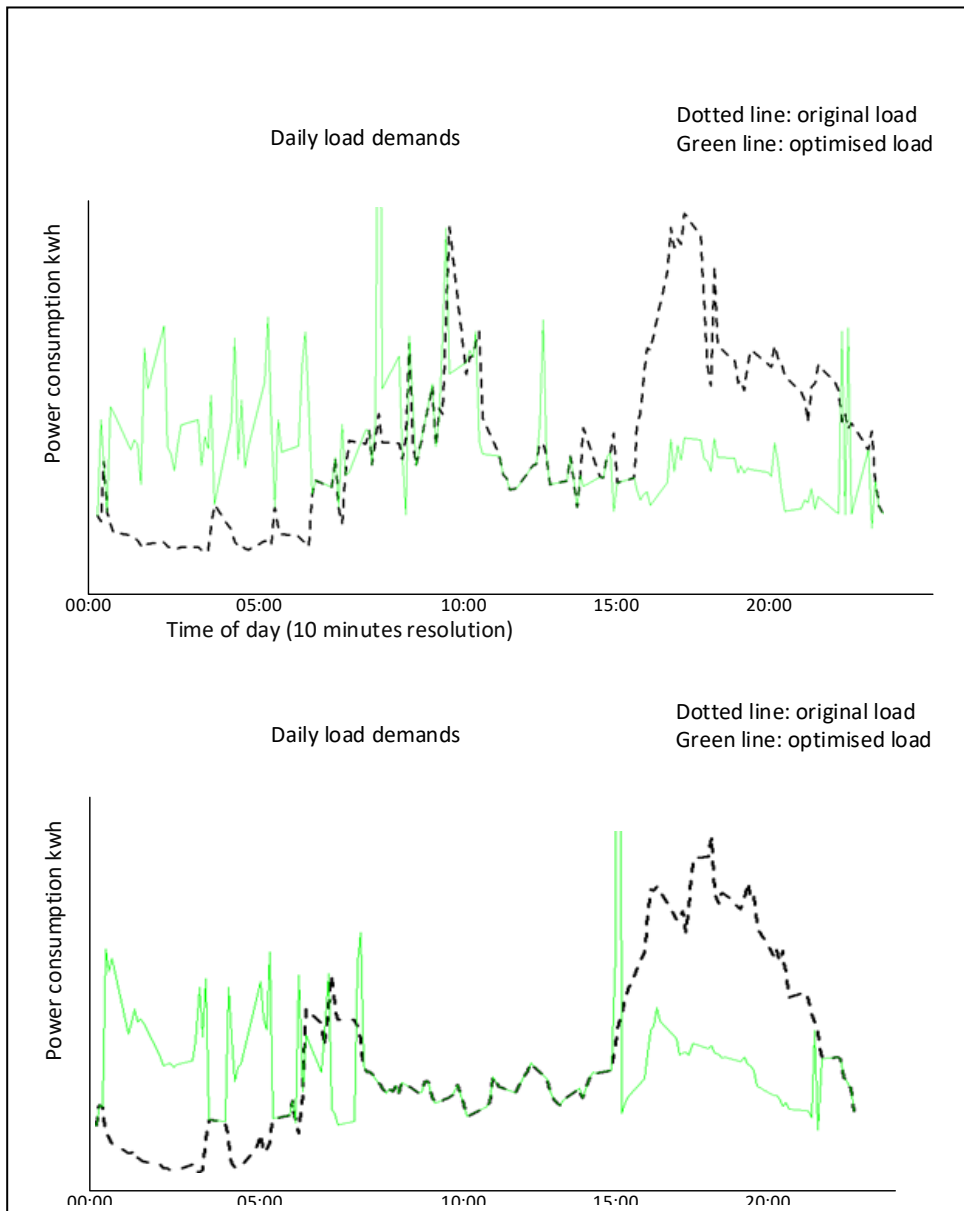

Figure 13 Unexpected high load appliances. The dotted line represents the original load while the solid line represents the optimised load

It has been noticed that some of real load profile data causes challenges to the proposed algorithm because of the short high load power of some R-users appliances. This study aimed to fix these challenges by adjusted the proposed algorithm then the real load data was applied to this algorithm to prove the changes work. However, with higher usage variance and faster changes with few off-peak time slots to reallocate the shifted energy, it is possible to see a scenario in which the proposed algorithm may fail to improve the R-users' power consumption load profiles. Nevertheless, to illustrate this, more real load profile data is needed to investigate these kinds of scenarios.

3.4 System framework for a novel mathematical modelling optimisation

3.4.1 Introduction

Mathematical modelling optimisation is an applied stage to minimise the PAR for R-users by providing an optimal scheduling solution. The aim is to produce a new mathematical model that can conclude an optimal scheduling solution, rather than sub-optimal scheduling solutions depending on how the load profile data sets are parsed, as proposed by two previous novel energy management stages (for more details, see sections 3.2 and 3.3. As mentioned in sections 2.4 and 3.1, previous studies have not provided details in the appliance-by-appliance level, adequate

regularisation for real load profiles to satisfy modelling purposes, and the framework to include all the above extensions. Therefore, this study proposes a new stage that is needed to overcome the necessary extensions that are missing in previous studies. This stage is a new mathematical model that aims to reduce the PAR and decrease the load demand fluctuation. A new energy management system, which describes how the proposed mathematical model stage is linked to other R-user entities and the community-based server, is articulated. The new energy management stage aims to reschedule the power consumption of individual R-users and community consumption scenarios on an appliance-by-appliance level. It also aims to load and produce load profiles that are running in a short time slot granularity to and from the new mathematical model.

3.4.2 Formulation

The mathematical model proposed in this study uses mixed integer nonlinear programming (MINLP) with binary decisions to formulate the optimal scheduling solution. This model's advantages are that it produces an optimal scheduling solution, it is suitable for the current problem because the selection is based on a time slot by on/off decisions, and it is possible to add more constraints while these constraints involve on/off decisions (Wong, 2007). To find the optimal operation

schema, the main objective of this model is PAR minimisation, which is calculated below (Mohsenian-Rad et al., 2010b; Nguyen et al., 2012):

$$PAR = \frac{\max_{t \in T} \sum_{t=1}^T x_{e,t} + x_{s,t}}{\frac{1}{T} \sum_{t=1}^T x_{e,t} + x_{s,t}} \quad (1)$$

The daily power operation of appliances is divided into $T = 144$, 10-minute slots. In each time slot t , there is one meter reading of all household appliances for 10 minutes. $x_{e,t}$ and $x_{s,t}$ denote the energy consumption scheduling vectors for non-shiftable appliances and shiftable appliances for R-users, respectively. The requirements/constraints keep the non-shiftable load unchanged, control the shiftable appliances for 24 hours, and ensure the optimisation does not change the total daily shiftable load. The proposed general form of the optimization model for individual R-users and community-based EMS is as follows.

For an individual R-users:

$$\min \sum_{e=1}^E \sum_{s=1}^S \sum_{t=1}^T (x_{e,t} + x_{s,t} * P_{s,t}). \Delta t \quad (2)$$

Subject to:

$$x_{e,t} = \bar{x}_{e,t} \text{ Nonlinear constraint}$$

$\sum_{t=1}^T x_{s,t} * P_{s,t} = C_a, s = 1, \dots, S$ Linear constraint

$C_s = \sum_{t=1}^T x_{s,t}, s = 1, \dots, S$

$P_{s,t} \in \{0,1\}$ Binary decision variable

For multi-users:

$$\min \sum_{n=1}^N \sum_{e=1}^E \sum_{s=1}^S \sum_{t=1}^T (x_{n,e,t} + x_{n,s,t} * P_{n,s,t}) \cdot \Delta t \quad (3)$$

$x_{n,e,t} = \bar{x}_{n,e,t}$ nonlinear constraint

$\sum_{t=1}^T x_{n,s,t} * P_{n,s,t} = C_{n,s}, s = 1, \dots, S, n = 1 \dots N$ linear constraint

$C_{n,s} = \sum_{t=1}^T x_{n,s,t}, s = 1, \dots, S, n = 1 \dots N$

$P_{n,s,t} \in \{0,1\}$ binary decision variable

where N is the number of users, t is the time slot, S is the number of shiftable appliances, E is the number of non-shiftable appliances, T is the total period of time.

$x_{n,e,t}$, and $x_{n,s,t}$ are the power consumption vectors for essential (non-shiftable) appliances and shiftable appliances, respectively. $\bar{x}_{e,t}$ is the non-shiftable load vector which is the same load for all non-shiftable appliances in $\Delta t = 10 \text{ minutes}$. $C_{n,s}$ is the total requested load of a shiftable appliance during a day. $P_{n,s,t}$ is a binary vector with all possibilities of turning on (powering) the appliance during the time slots.

The purpose of the minimisation objective function in the mathematical model is to find the optimal lowest peak during the day by redistributing the power usage of shiftable appliances rather than sub-optimal power consumption distributions, which are produced by algorithm-based solutions. The number of binary vectors is equal to the number of shiftable appliances. Each vector is determined based on the current state of the objective function under the constraint that the number of *on* status slot times should be the same as the number of *on* status total daily requests load of the shiftable appliance. The time slot resolution is 10 minutes. The power profiles output of the proposed mathematical model are distributed back to individual R-users. These profiles are denoted by $x_{e,t} + x_{s,t} * P_{n,s,t}$, corresponding to the energy assigned for user *n* of appliances *s*, and *e* during the period of time *t*. $x_{n,e,t}$ is non-shiftable load vectors of all non-shiftable appliances at sample time *t* and user *n*. A $P_{n,s,t}$ is a yes-or-no decision, which is a contingent decision that can be yes only if a certain other yes-or-no decision is yes, as it was extended from a previous study by Morgenthaler et al. (2005). The output profiles of $x_{n,s,t}$ are real decision variables corresponding to a variety of power usage ranges of individual shiftable appliances operating in R-users. As a result, the mathematical model output should provide a decision vector in a certain sample time, Δt , of all shiftable appliances for R-users.

It is noteworthy to refer that the possibility space, which covers all possible scheduling vectors by the proposed mathematical model to produce the optimal schedule operation vectors, is significantly high. The number of possibilities of these contingent decisions is significantly increased when the number of shiftable appliances and operation time slots are increased. For example, given one user with six shiftable appliances and a sampling interval of $\Delta t = 10$ minutes, the number of possibilities is $1.999507e+256$ for the whole day, as calculated by permutation for the number of all shiftable slots, which was 6×144 equal to 864, and the number of shiftable operations on slots upon them was 479. With multiple R-users, this number is massively increased. An exhaustive algorithm would cycle through all the possible permutations to identify the optimal scheduling solution.

This on/off status decision variable is a common procedure to produce the optimal appliances scheduling vector, which was applied in previous studies (Sou et al., 2011; Tsui and Chan, 2012; Tushar et al., 2014; Yahia and Kholopane, 2018). There are two main disadvantages of using binary decision variables in mathematical modelling: computational burden and decision coarseness. First, the computational time of optimal scheduling may significantly increase by adopting a large number of variables; second, the power consumption reallocation in this type of formulation is

restrictive because the power consumption patterns are binary, on/off usage (Wong, 2007).

3.4.3 Model integration into the environment

To implement the proposed mathematical model, which is described in 3.4.2 Section, into the system environment, which is described in 3.2.2, the following system architecture is proposed. Figure 14 illustrates the basic system architecture for the proposed work, which is an extended architecture from the previous two studies (Yaseen and Ghita, 2019, 2017).

The proposed energy management is composed of single R-users' EMSs connected by a community server EMS, as the previous environment definition in Section 3.3.2. Hence, an extension for individual R-users' solution was added to provide the power optimisation algorithms and mathematical models' periodic implementation based on time sampling Δt in individual EMS'. The implementation of the mathematical model considers all power usage types (shiftable and non-shiftable) at each time slot, but without consideration of power usage patterns of other R-users in the community. In a community-based solution, the EMS running on the community server is responsible for the optimal scheduling of the shiftable appliances for all R-users. This scheduling considers all shiftable and non-shiftable loads of R-users that are operating in time sampling Δt . With regard to the proposed optimisation

mathematical model and related algorithm solvers, it is allocated in R-users and community-based EMS in single and community-based scenarios, respectively. The main condition for generating the optimal operation decisions in these time slots is the power usage of shiftable and non-shiftable loads in watts. Notably, the operation decision is a contingent decision because changing individual slots has an impact on their slots neighbours, particularly with a goal of PAR reduction. In the single R-user optimisation scenario, the proposed mathematical model receives power consumption reports from all appliances then prepares the power load profiles. An important input to feed the mathematical model is addressing the shiftable and non-shiftable appliances, whereby the shiftable load is regularised to discrete values. On the contrary, the non-shiftable load is fed to the proposed mathematical model as given in a nonlinear form with continuous values. The output of the mathematical model is the optimal scheduling of all shiftable appliances during a day.

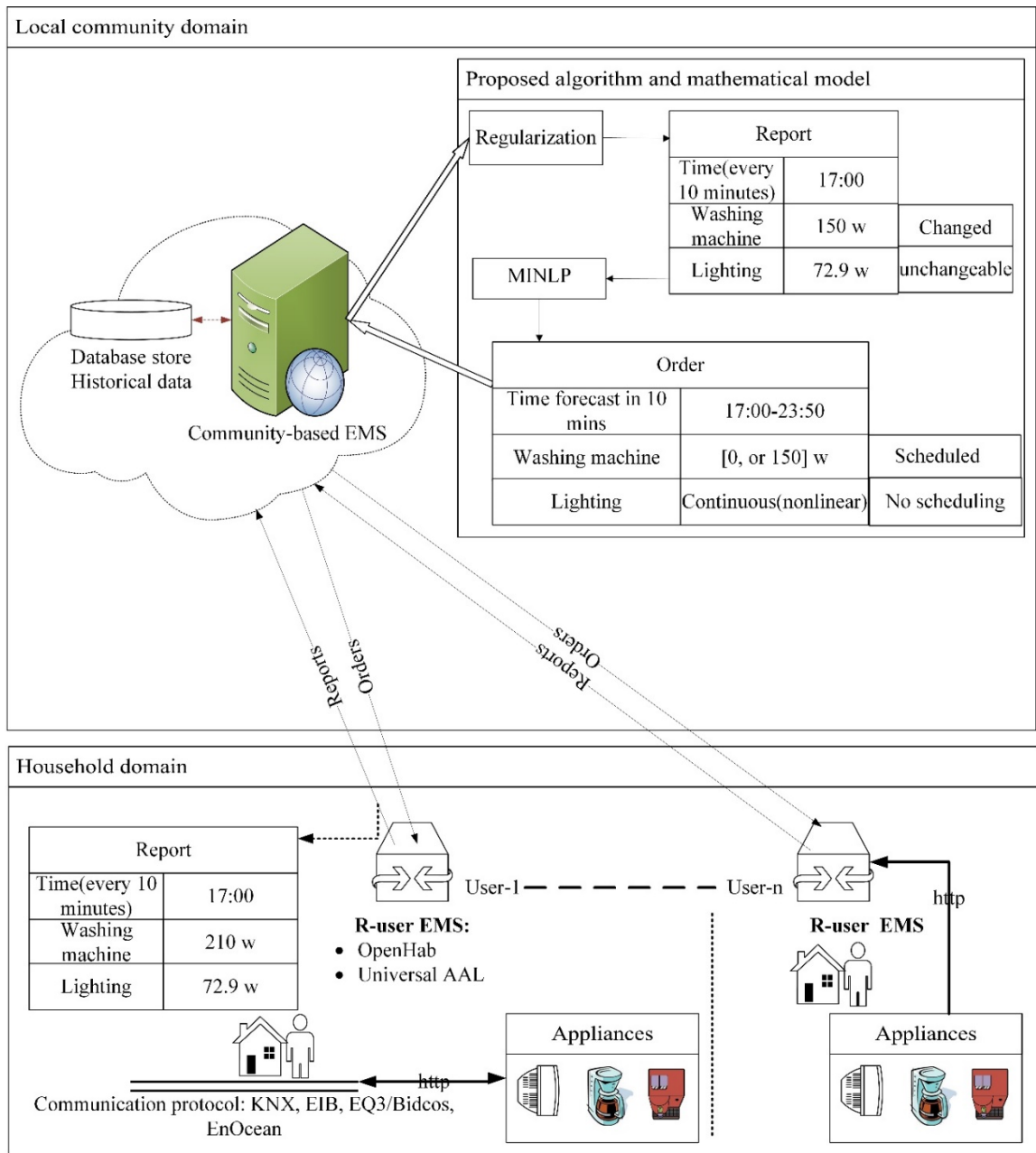

Figure 14 System architecture for the mathematical model

Prior to the implementation of the proposed mathematical model and its architecture, a further pre-processing procedure is required to ensure the shiftable load meter readings are compatible with the linear constraint or yes-or-no decision. With regard to real-world load profiles, there are two types of power usage meter readings. First, there are non-shiftable load power usage meter readings, which are directly applied as its measured form in the proposed mathematical model. However, it is not applicable to directly apply the shiftable load data into the proposed mathematical model, as a wide range of power usage meter readings was recorded, such as a period from 0 to 300W in one appliance. This wide range of meter readings is not applicable to the proposed constraint form, which is $P_{s,t} \in \{0,1\}$, the binary decision variable of the proposed mathematical model. As a result, the shiftable load meter readings need to be regularised into a form of either 0, or potential power usage value. This new form of these two meter readings of each shiftable appliance is according to the constraint format of 'yes or no'. To automatically apply a uniform regularisation process for all shiftable appliances, a new step called the regularization step was added before the mathematical solver implementation as an extension to Tsui and Chan's (2012) study. Therefore, applying the regularization step enables the optimisation process of shifting the shiftable load to take place.

The wide range of power usage meter readings depends on individual appliances' power usage pattern. For example, the power consumption of one shiftable appliance in the real measured data set could be varied such as 0, 0.1, 0.7, 187, and 280W during a day. For multi-functional shiftable appliances, this range of power usage variation is increased, such as a washing machine starts by heating, washing, then drying with different power consumption values during each function. This variation load consumption reflects the real power consumption per time slot, as a shiftable appliance could consume power for its LED display only then, after starting the job, consume more power and reach its highest power usage then go down to a steady power usage before the power usage slowly reduces when it finishes the function. However, as the modelling requirement stated that individual shiftable appliances should be either on or off status, the current real data set needs to be rewritten. The output of the rewritten process needs to be as close as possible to the real consumption patterns of all shiftable appliances operating for all R-users. The following 3.4.4 section describes this rewritten process in more detail.

3.4.4 Empirical testing using real-load data profiles

The load profiles show that there is a variability in the amount of electricity consumed by each device at any given time when they are turned on. To easily deal with the data, it is important that the consumption is regularised the *on* state to a specific level

of consumption such that when an appliance is turned on it is deemed to be consuming a fixed level of energy. However, just applying a fixed threshold without adjusting it based on the data, such attempt may not closely approximate the real data in this thesis. Therefore, a regularisation method is proposed in this section. To keep the regularised load profile data as close as possible to the real-life scenario and to overcome disadvantages of using binary decision variables (*on, off*) to some level of extension, in this study, the regularisation procedure is added before applying the proposed mathematical model. This procedure begins with the appliance-by-appliance analysis step. This step is used to define the actual use of shiftable appliances, which are running for individual R-users rather than adopting a varied range of power usage meter readings at each time slot of a real-world scenario. This type of meter reading adoption is challenging to formulate. This analysis step is an extension to previous work by Setlhaolo and Xia, (2015). Typically, appliances operate with different power usage among R-users. The aforementioned analysis step considers a solution to overcome the issue using previous studies, which assumed the same power usage was assigned for all appliances depending on the appliance type in overall R-users, e.g., washing machines consume the same x watts for all R-users, which is not practical. The result of the analysis step of each shiftable appliance is considered in the formulation of

the corresponding constraints. This step gives validity for the proposed system to be accepted to all R-users' appliance power levels in a real-life scenario.

Let the set of time slots be $T = \{1, \dots, 144\}$. Now, for an appliance s and a user n at time slot t , the power usage is denoted by $x_{n,s,t}$. Therefore, the vector of power usage for a user's specific appliance is given by:

$$\mathbf{x}_{n,s} = (x_{n,s,t})_{t \in T} \quad (4)$$

With this, there is a range of meter reading values of individual shiftable appliances. However, to conclude, the closest usage patterns (on, off) to meter readings in real-life scenarios where different R-users would have different power usage values for their shiftable appliances, the regularisation process for all R-users' appliances is required. In this study, this process is needed to adjust the requirements of the proposed mathematical model (for more details, see 3.4.2 Section). This procedure is implemented in a community-based server or R-users' gateways depending on the applicable scenario, which is either the community-based or single R-user scenario, respectively.

For transferring the wide range of power usage values into either estimated *on* power usage, or zero values *off* for each appliance, Coordinate Descent (CD) algorithms are ideal optimised to exploit such sparsity, in an obvious way. CD algorithms are

iterative methods in which each iteration is obtained by fixing most components of the given variable vector. This vector is power usage values in this study, values from the current iteration, and approximately minimizing the objective with respect to the remaining components. Each such subproblem of individual values is a lower dimensional (even scalar) minimization problem, and can typically be solved more easily than the full problem (Wright, 2015). Therefore, such algorithms are commonly used for regularization procedures (Friedman et al., 2010). For transferring the wide range of power usage values into either potential power usage, or zero values in each appliance, there are two main requirements to implement CD into the real dataset in this study. These requirements are determining the potential power usage value, which is considered as an initial threshold, and operation range periods of a shiftable appliance. These periods represent the actual usage time during the day for each appliance. It is clear that the threshold value of power consumption for *on* status for different shiftable appliances for one user is different. In addition, it is a different value of power consumption for *on* status of the same shiftable appliance operating for different R-users. To produce a general procedure for effectively finding these requirements, which need to be applicable for all R-users' appliances, the following process is applied and validated.

With this, a natural threshold to set is the mean of the $x_{n,s}$, so anything above the mean is *on* state and anything lower than the mean is *off* state. However, it has been noted that there are large fluctuations, so a conservative approach is considered, and the standard deviation (SD) was added to the mean for more accurate threshold. This threshold is used for selecting the potential power usage single value of individual shiftable appliances for each R-user (Wright and London, 2009). As a result, any individual load value in $x_{n,s}$ will be on if it is above the threshold and any individual value below the threshold will be off. It is trivial to compute the mean $\mu(\cdot)$ and standard deviation $\sigma(\cdot)$ of this vector. Now, the potential power usage $u_{n,s}$ can be defined as follows:

$$u_{n,s} = \mu(x_{n,s}) + \sigma(x_{n,s}) \quad (5)$$

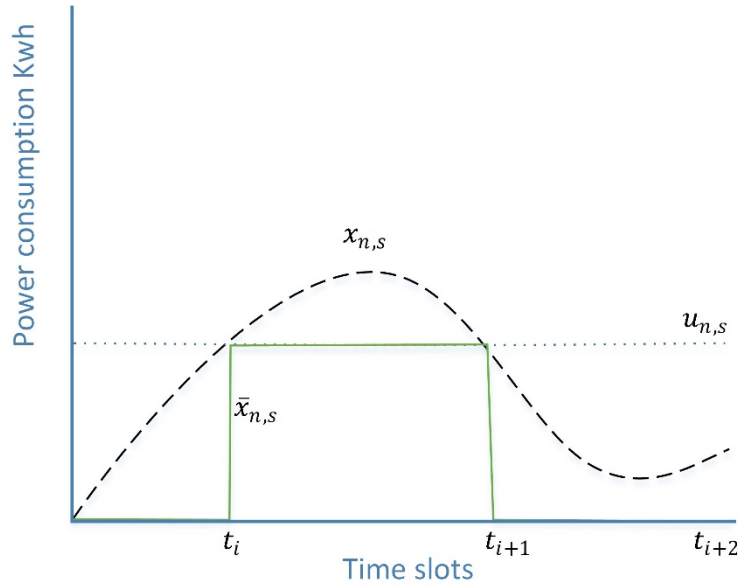

Figure 15 Two power signals before and after applying the potential power usage threshold

Figure 15 shows when the potential power usage threshold for a meter reading power signal is applied; it is clear the output signal $\bar{x}_{n,s}$ is shifted from the original signal $x_{n,s}$. Moreover, there are residuals that are left at the end of this process, as shown in Figure 16 and denoted by d_i . Clearly, this is a conservative estimate of the potential power usage as the uncertainty (or the fluctuations) was added with the mean. To distinguish between time slots that are greater than $u_{n,s}$ from the ones that are less or equal, let $M = \{i | i \in T \wedge X_{n,s,i} > u_{n,s}\}$ and $P = \{i | i \in T \wedge x_{n,s,i} \leq u_{n,s}\}$ be the sets of these differing time slots.

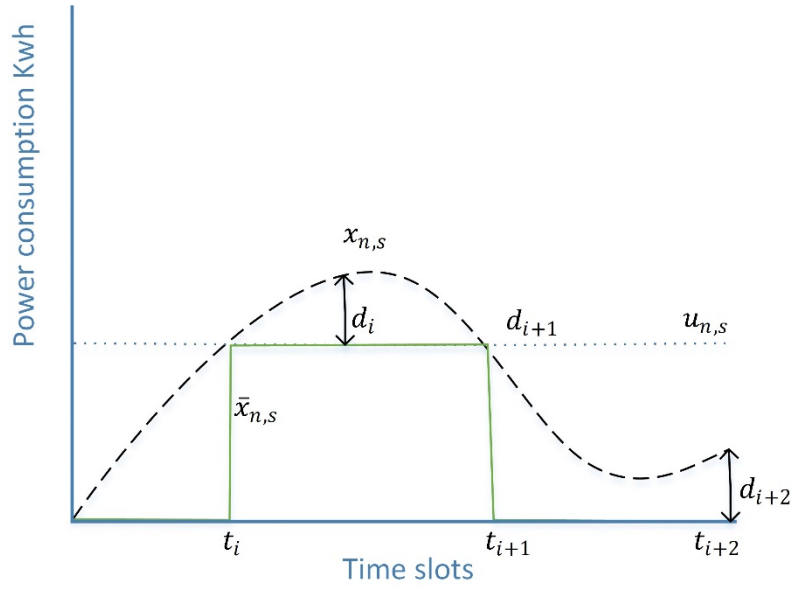

Figure 16 Residuals between two power signals after applying the threshold

To adjust the aggregated residuals in the regularized power signal, an initial threshold was first started with $\theta_{n,s} = u_{n,s}$ and an aggregated residuals metric $d_{n,s}$ defined, as follows:

$$d_{n,s} = f(\mathbf{x}_{n,s}, u_{n,s}, \theta_{n,s}) = \sum_{i \in M} (x_{n,s,i} - u_{n,s}) + \sum_{j \in P} x_{n,s,j} \quad (6)$$

The number additional on time slots that need to be considered for the initial threshold is defined as $c_{n,s}$ and calculated as:

$$c_{n,s} = d_{n,s}/u_{n,s} \quad (7)$$

To perform a coordinate search (Friedman et al., 2010) in the power usage data to locate the most appropriate threshold for discretising this data in appliance-specific binary on or off states, the following pseudo-code was applied. First, to address the slot number $c_{n,s}$ in the regularised power usage output signal of a daily shiftable appliance operation, a search step has been done for finding the time slots of the power usage values in the meter readings $x_{n,s}$, which are less than the initial threshold and closer to this threshold value. Second, all the slots in M , as well as the selected slots in $c_{n,s}$ need to be replaced into on status. $g_{n,s}$ is used to sort the power usage values and save the time slot address for these values. It is useful to allocate the accurate time slots that are needed to turn on depending on $c_{n,s}$. Next is reassigning the threshold backwards based on the number of replaced slots for the number of appliances s in user n as $\theta_{n,s} = x_{n,s,g[|M|+c]}$. $\theta_{n,s}$ is the updated threshold of the potential power usage in each individual appliance after the regularisation procedure. Currently, it seems useless, however, typically it is useful to store this value in the load profile data and linked it to the individual shiftable appliances which could be used later as an indicator for potential usage of the appliances. To apply a robust procedure that can handle the regularisation process for all R-user' load profiles, the following Pseudo code 2 was proposed:

Pseudo code 2 regularisation process of individual shiftable appliances

Regularise $(\mathbf{x}_{n,s}, u_{n,s}, d_{n,s}, T, M, c)$

$$r_{n,s} = (r_{n,s,1}, r_{n,s,2}, \dots, r_{n,s,|T|}) = (0, 0, \dots, 0)^T$$

$$\mathbf{g}_{n,s} = \text{argDescendingSort}(\mathbf{x}_{n,s})$$

For $i \in \{1, 2, \dots, |M| + c\}$

$$r_{n,s,\mathbf{g}[i]} \leftarrow u_{n,s}$$

ENDFOR

Return $r_{n,s}$

3.5 Conclusion

This chapter proposed a novel energy management system that involves three stages for PAR minimisation based on redistributing power usage for shiftable appliances. Existing power optimisation schemas are struggling to describe a solution with a community-based scenario, appliance-by-appliance analysis, and real load profiles. They are also struggling with analysing users' willingness to allow an automatic system to control users' power usage. In addition, there has been little detailed investigation in using mathematical models, which gives the optimal scheduling pattern solution rather than suboptimal scheduling patterns obtained by algorithm-based energy management systems. Therefore, this chapter proposed

and demonstrated three novel energy management systems to overcome the above-mentioned optimisation issues. For each proposed stage of the energy management system, the following aspects were discussed: reports and orders of power consumption scheduling, which flow between R-users and the community-based server, the core optimisation procedures and their process flow of each novel energy management, and real-load profiles' impact on the system model design in each stage. As a result, these novel energy management systems are ready for practical evaluation using real-load profiles of power consumption with as small granularity as possible to enable accurate validation.

4. Experiments and results

This chapter presents an evaluation of the proposed stages for an energy management system, focusing in particular on the benefits and variations brought in by individual improvements and community-based improvements. In addition, the data set environment and the process of loading R-users' profiles are presented in this chapter. A series of experiments were applied to each proposed novel energy management system, which includes the difference between single and community, and analyses and solutions for real-time load profile issues in each of the proposed systems.

4.1 Data source environment

In this chapter, all the experiments in this study consider a smart power system consisting of a single energy provider and multiple R-users. The households' appliances are monitored over 24 hours at an appliance level with a granularity of 10-minute intervals. In this work, the users' power usage profiles were loaded from the dataset provided by Cambridge Architectural Research (CAR) and the Department of Energy and Climate Change (DECC) in the U.K (Jason Palmer et al., 2013).

To evaluate the performance of the proposed stages, R-users were grouped into different community sizes. Grouping R-users to evaluate proposed energy management systems was used by prior research works. Ross (2015) divided R-users based on utilizing a proposed technology to reveal the experiential world of these users. The goal was to document how proposed systems impact power usage in both the energy consumer and generator contexts. Akter et al. (2017) mentioned that energy management systems applied in different groups provide different optimisation percentages. Their experiment was applied to prioritized R-users and led to reducing energy poverty within the microgrid with the assumption that traditional houses were the lowest-income community members who could not afford renewable energy resources while proactive and enthusiastic neighbours were comparatively more solvent.

In this study, to evaluate the optimisation percentages of proposed stages for different sizes of R-user communities, different R-user scalability groups were applied, such as single, mini, and large R-user groups. Dividing R-users based on group size was applied by Mamounakis et al. (2018), who only divided R-users into two groups, individual and mini groups, of four R-users each. Selecting particular R-users in each group requires a study beyond the scope of the current work. However, selecting random R-users' load demand profiles for each group was applied in this

study to ensure a realistic distribution, as previously used by a prior work (Khadgi et al., 2015). Generally, it has been proved that all community groups provide better power optimisation percentages compared to individual R-users. Besides, the optimisation percentage of specific groups might significantly drop down, for example, group-2. This is results from the R-users of these groups having issues with their appliances, and/or the R-users' power usage patterns aggregated in a form that is challenged for the proposed stages to move the power consumption during peak load times to suitable off-peak time. These issues and solutions are discussed later in sections 4.2 and 4.3. This grouping is useful to analyse how the load profile combination impacts the scheduling decisions as a result of optimisation percentages by the proposed stages. It is been showed that the community-based solution is always better than single optimisation with disregard to how the load profiles are combined or/and how big the community is.

Fifteen samples of user profiles were grouped for performance analysis of the three novel energy management stages, which were explained earlier in Chapter 3. These user profiles were selected in a thorough manner based on users' criteria. These criteria were house type, house size, the month of reading the power usage, type of day (holidays or workdays), day temperature level (hottest, coldest), and heating types of the house, household size, and family status. For each criterion, there were

several options, such as house type options (detached, semi-D, mid-terrace, end-of-terrace, flat, bungalow, all) and house size options (0-49 m², 50-99 m², 99-149 m², 150-199 m², and 200+ m², and any size dwelling). Regarding the presented information from CAR, each user had at least one different option from the list of criteria while other users with the same criteria were locked.

Therefore, attention was paid to keep the criteria variation of selected users consistent in terms of the time of the year, to ensure the results were meaningful (such as avoiding selecting two power profiles of users for optimising their power usage, such as one user having his power load profile measured in January while another user having his power load profile measured in July because of the great difference in temperature of these two months, which will affect power usage).

Therefore, four groups of users were generated: group one was based on profiles collected in January, working days, hottest day; group two was the same as group one, but with no specific day; group three used the constant criteria as the second group, but differed by further changing the rest options in the order top to down, as provided by the load profiles software tool. To provide a bigger community for evaluating the performance of the proposed stages, a fourth group was created by joining the previously described three groups. A load of individual user profiles was measured during a 24-hour cycle with 10-minute resolutions. Eleven types of

appliances were measured at each time slot of 10 minutes. 144 meter readings associated with 10-minute timeslots for each appliance were analysed and rescheduled based on the three novel energy management systems implemented in R. R is a programming language and free software environment for statistical computing and graphics supported by the R Foundation for Statistical Computing.

4.1.1 System formulation and the evaluation metrics

In the experiments of this study, users were equipped with a number of appliances and was denoted by M_n . S_n and E_n were denoted lists of names for shiftable appliances and essential appliances (non-shiftable appliances) for user n respectively. The intended time of operation was divided into $T = 144$ 10-minute slots. In each time slot, there was one meter reading for all households' appliances each for 10 minutes in one day. Then, the energy consumption scheduling vectors for S_n, E_n were $x_{n,s}, x_{n,e}$ for shiftable and non-shiftable appliances, respectively. The following equation was used to compute the $l_{n,t}$ for load demand of n user at slot time t :

$$l_{n,t} \triangleq \sum_{e,s \in M} x_{n,e,t} + x_{n,s,t} \quad (8)$$

And the total daily load L_h of n user could be found as below:

$$L_h \triangleq \sum l_n^t \quad (9)$$

The beginning and ending of daily operation time for shiftable appliances was $\alpha_{n,s} \in T$ and $\beta_{n,s} \in T$ while the minimum power for each appliance was $x_{n,m,t} \geq y_{min,n,m}$. Based on the above notation, PAR could be formulated in terms of load demand for one user as Equation (1) in Section 3.4.2 and the PAR minimisation problem could then be formulated to find the minimum possible value of the maximum daily load, as follows:

$$\min_{x_i, \forall i} \max_{t \in T} \sum l_{i,t} \quad (10)$$

4.2 DSM experimental methodology and results

To experiment on the effectiveness of the proposed DSM, which was previously explained (for more details, see Section 3.2), this section provides the experimental results of the proposed DSM for single and multi-users. In this experimental work, the impact of the proposed DSM is discussed during three different daily load periods, which were off-peak, mid-peak, and peak times. Also, the possible issues raised by combining individual load profiles is discussed. The performance of the proposed DSM in a community-based solution over single users is presented.

Regarding the performance of the proposed DSM on single-users, the impact of this DSM was evaluated by comparing the load demand following the application of the shiftable management, with the original load demand for the same household with power loads. Figure 17 shows the results obtained using power consumption management. It can be concluded from this figure that the PAR of the algorithm-based load was appreciably lower than the PAR of the original load, where the PARs of both loads were 1.4 and 1.5 for the algorithm-based load and original load, respectively.

It is evident the PAR results obtained here are exceptionally good agreeing with existing PAR results of Mohsenian-Rad et al. (2010b) and Nguyen et al. (2012), which were minimised from 1.8325 to 1.8315 and 1.8 to 1.6, respectively. The peak load interestingly decreased from 725.5W at 6:10 pm to 671.1W at 6 pm. As can be seen, during both daily peak time periods the algorithm-based load demand of the household was significantly less than the original load demand, which was consistent with the results obtained in a previous study (Ikegami et al., 2010). However, the algorithm-based load demand in this study was not consistent with a number of studies (Mohsenian-Rad et al., 2010b; Mohsenian-Rad and Leon-Garcia, 2010; Chen et al., 2011; Yang et al., 2013; Liu et al., 2014; Khadgi et al., 2015) that used merely random load or who adopted additional energy storage devices such as

battery, renewable energy resources, and distributed generators (Nguyen et al., 2012; Manasseh et al., 2015; ImranKhan and Saleem, 2015). Concerning different daily load periods, it can be seen that for the first hours of the day from 00:00 to 06:00 am (off-peak), the algorithm-based load resulted in a considerably higher level than the original load; however, in this period, the energy was easier and cheaper to produce, which is an advantage for both power companies and users.

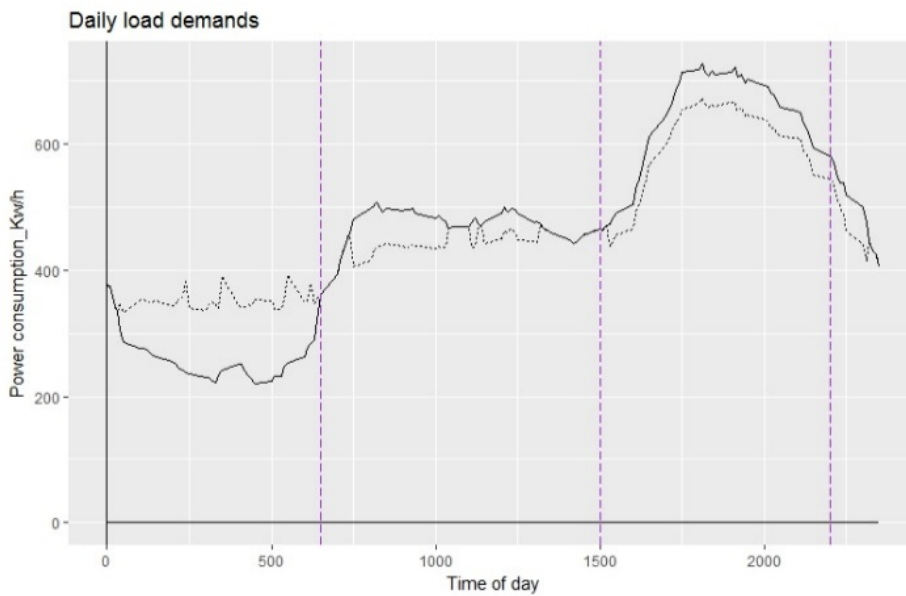

Figure 17 Power consumption for (a-solid line) original household demand and (b-dotted line) proposed DSM algorithm.

During the second period of the day from 06:00 am to 4:30 pm (mid-peak), the algorithm-based load was significantly less than the original load. As a result, the benefits for users and providers were applied, where providers have a match between supply and demand. During the last part of the day from 04:30 pm to 23:00 pm was the most problematic period for both users and providers. In other words, at peak times, users pay twice as much as at off-peak times while providers always have issues with the supply and fulfilling demand. The algorithm-based load was advantageous compared with an original load.

As can be seen in Table 5, which includes 15 R-users, the results mostly indicate the new power load consumption has been optimised compared to the original power usage. However, there are rare cases when the suggested optimised management was not able to optimise the power usage load profile, such as with user-13 and user-15. The main reason was the high power usage of their shiftable appliances, as explained earlier and will be explained further (see Section 3.2.4 and Table 8, respectively).

Table 5 The impact of the proposed DSM algorithm in the single R-user scenario

ID	PAR before optimisation	PAR after optimisation

User- 1	1.85	1.48
User- 2	2.24	1.82
User- 3	2.36	2.14
User- 4	2.36	2.26
User- 5	1.76	1.66
User- 6	1.83	1.53
User- 7	1.93	1.69
User- 8	2.18	1.87
User- 9	2.1	1.74
User- 10	2.59	2.18
User- 11	1.69	1.31
User- 12	1.78	1.42
User- 13	2.02	2.02
User- 14	1.67	1.45
User- 15	2.07	2.07
Average	2.02	1.77

In this study, with respect to DSM in a community-based optimisation, this DSM has shown better performance than in the single user scenario. DSM in a community-

based setting was applied for the aforementioned 15 power load usage profiles of the R-users, which were divided into four groups, as earlier explained (see Section 4.1). Notably, the optimisation percentage range of this scenario was 5.63% to 23.22%, which was greater than the single scenario results, as can be seen in Table 6. To compare the daily power usage pattern profiles for the 10-minute resolution of these groups before and after applying the proposed DSM, group-1 was used to experiment with the proposed DSM.

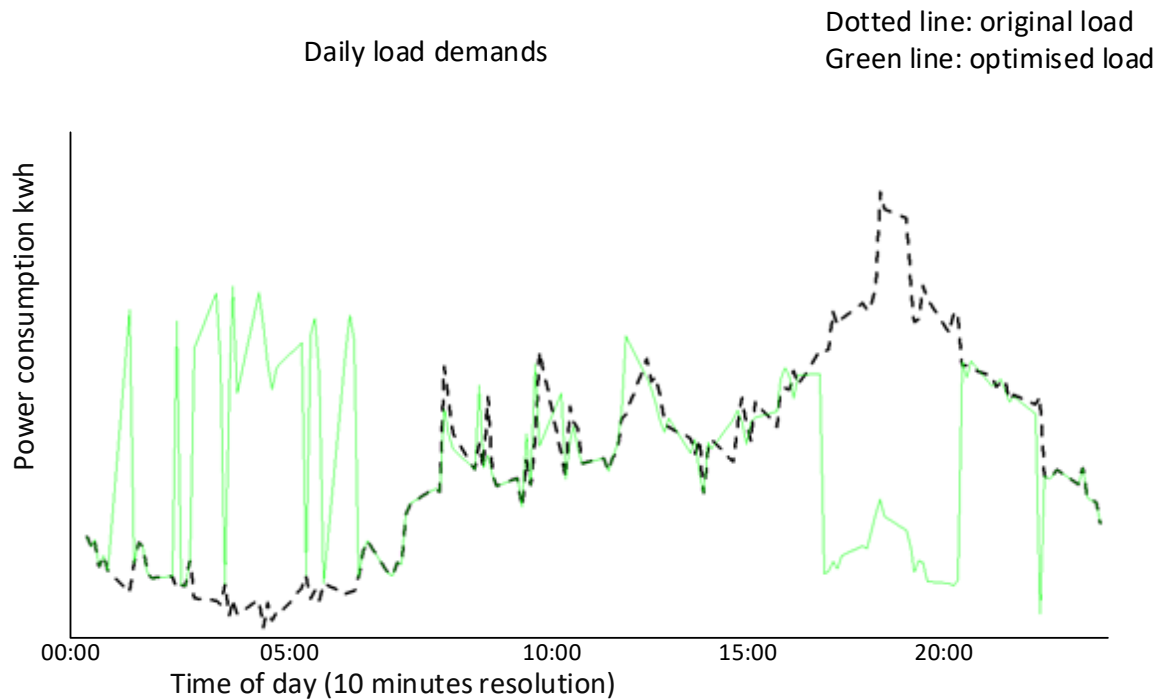

Figure 18 shows the power usage of all R-users in group-1 before and after applying the proposed DSM. In this figure and the other results' figures, the dotted black line

is the original household demand and the green line is the proposed algorithm-based demand. Table 6 depicts the PAR results of four groups before and after applying the optimisation management, in addition to the optimisation percentages of each group. Clearly, three of the groups, group-1, group-3, and the community group, have higher optimisation percentages in the community-based solution compared to the single user solution. However, although group-2 has good optimisation percentage compared to the original load profile without optimisation, this optimisation percentage of 5.63% was not as high as expected of the community-based solution.

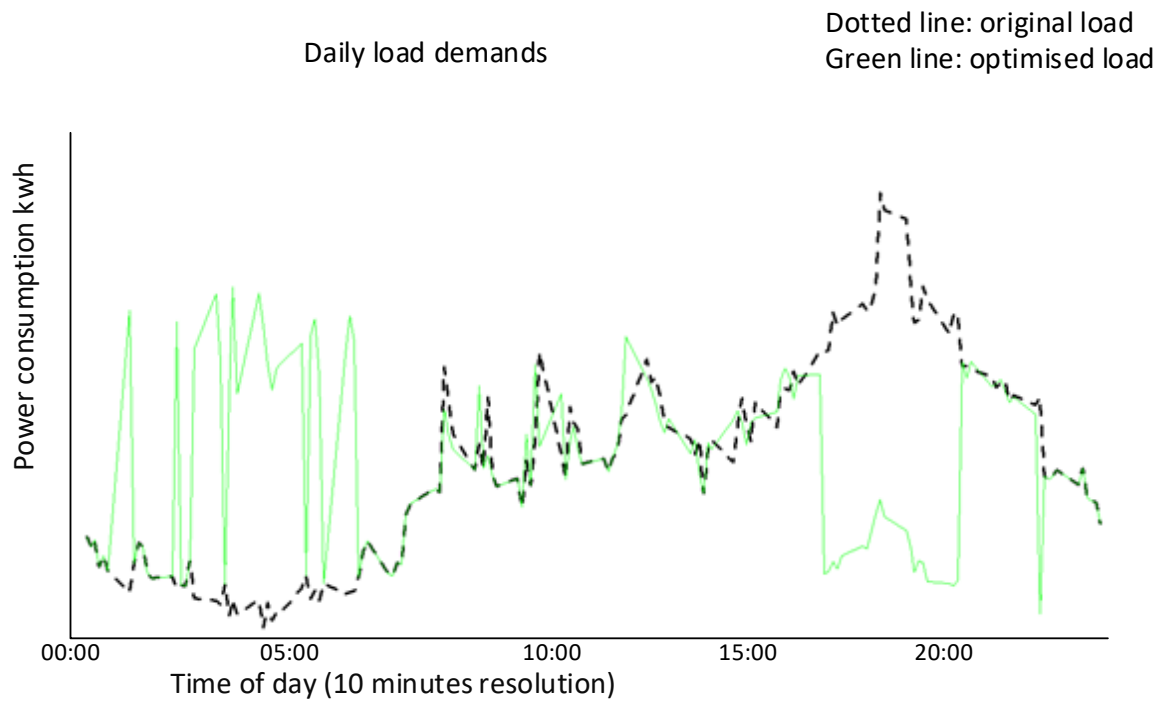

Figure 18 Power usage of all R-users in group-1 (a-dotted line) original household demand and (b-green line) proposed DSM algorithm.

Group ID	PAR before optimisation	PAR after optimisation in the single-user scenario	PAR after optimisation in the multi-user scenario	Optimised percentages in the single-user scenario	Optimised percentages in the multi-user scenario

Table 6

Group 1	2.11	1.87	1.62	11.37%	23.22%
Group 2	2.13	1.8	2.01	15.49%	5.63%
Group 3	1.85	1.64	1.51	10.81%	18.38%
All community	2.03	1.77	1.57	12.31%	22.66%

Comparison before and after applying the proposed system for four groups

To understand the low optimisation of community-based management for group-2, this group has been exceptionally studied and analysed. Figure 19 provides an overview of the power usage of all R-users in group-2 in 10-minute resolution. Two main issues were found in this R-user group. The first was an individual R-user issue related to an unexpectedly high load power usage of the individual shiftable appliances. The number of requests of these individual shiftable appliances was calculated, as previously explained in the DSM proposed system in Section 3.2, and these failure requests substantially reached 1740 per day for R-users in group-2. Basically, the algorithm considers a failed shiftable request after the following condition occurs: if the new aggregated load at the given time slot is higher than the average load, then this request is considered a failed shiftable request, as can be seen on the novel DSM flowchart in Figure 9 in Chapter 3. This condition is always

checked before starting the shifting process of each individual appliance of all R-users in a given community.

The second issue was a community-based one concerning the average load value found by the historical data of all R-users in the community. This average load value was low for this group, but the power usage peaks of the individual users were high and concentrated at the same time slots of the day. Therefore, as the average load was low for R-users of the group, the suggested optimised algorithm was not able to shift most of the shiftable load at concentrated load time slots to less power usage load time slots. The average load was regularly monitored for individual shifting requests of the shiftable appliances, as previously explained in the DSM proposed system in Section 3.2. One of the suggested solutions is increasing this average load value, which might lead to a better PAR optimisation value, as the number of shifting requests would increase. The increased percentage depends on several failure requests and concentrated operational time slots for these requests. In this study, the increased value of 23% leads to improving the results. Because of the increase of the average load, the optimised algorithm was able to shift most of the shiftable load that in operation at the concentrated power usage times. As a result, the new PAR decreased to 1.51, which is equivalent to 29.11% rather than only 5.6% before

adjusting the average load. Figure 20 shows the power usage of all R-users in group-2 after adjusting the average load value.

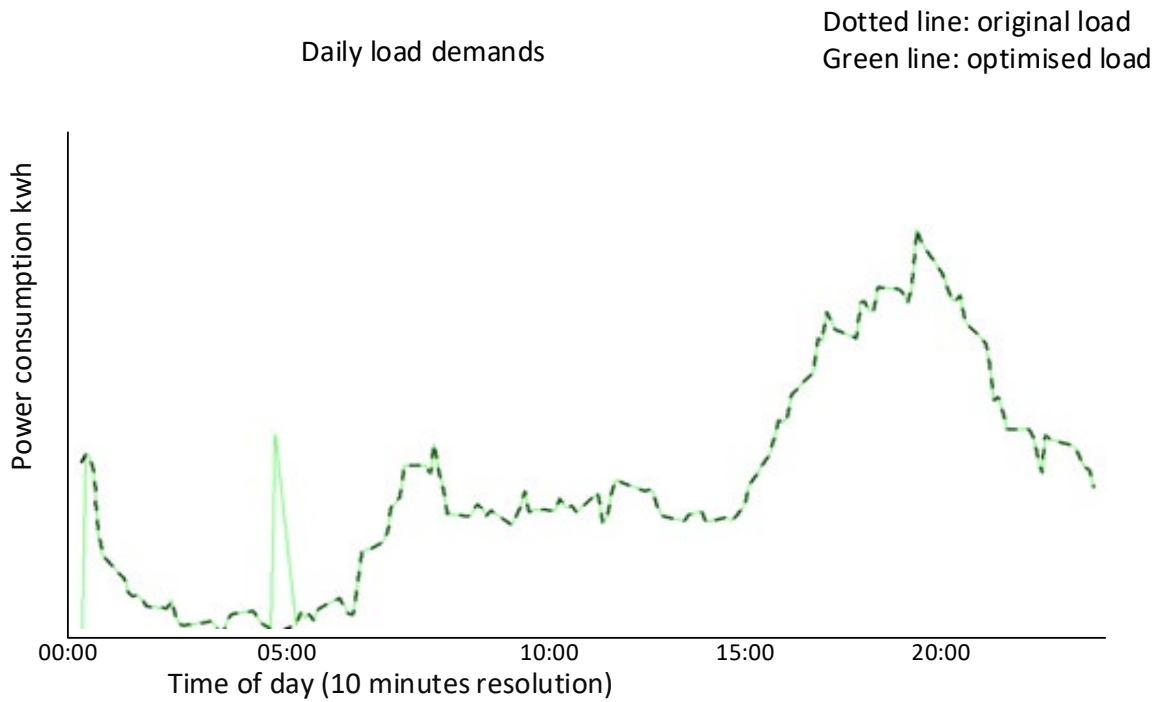

Figure 19 Power usage of all R-users in group-2 before changing the average load value

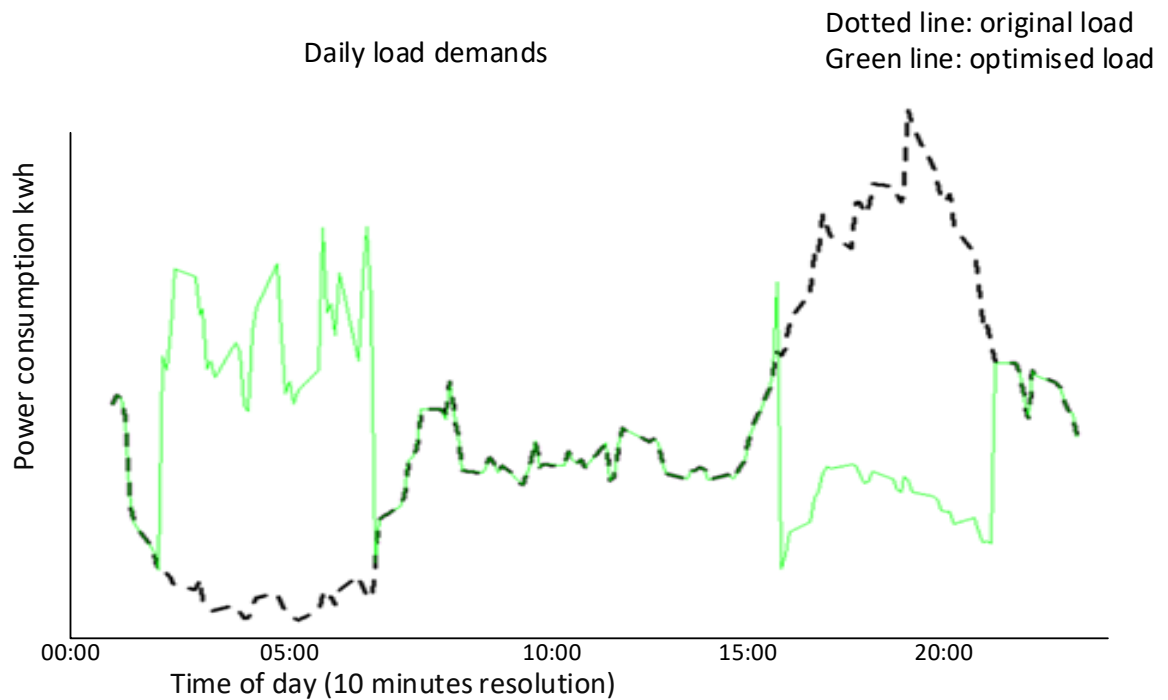

Figure 20 The power usage of all R-users in group-2 after adjusting the average load value

4.3 EMS with R-users' willingness experimental methodology and results

The current investigation involved optimising power consumption while considering users' willingness using the proposed system, which involved the proposed EMS algorithm (as explained in detail in Section 3.3). The willingness value is a measure of the user's acceptance level to allow an automated system to control the household's power consumption. In this work, the users' power usage profiles were

loaded from the dataset provided by Cambridge Architectural Research (CAR) and the Department of Energy and Climate Change (DECC) in the U.K. (Jason Palmer et al., 2013) (for more details, see Section 4.1). A total sample of R-user profiles was grouped for performance analysis of the proposed EMS algorithm, which was explained earlier. These selected users' load profiles were used to evaluate the performance of the proposed EMS algorithm in two scenarios: a single scenario with willingness, and a multi-user scenario with willingness. All single users aimed to optimise the scheduling of their power usage using EMS. Regarding the assigning users' willingness values, these values were randomly applied to these users. The random values for willingness support the development and deployment of the proposed stage by allowing for considering a wide range of environmental conditions, exploring the unknown, and the learning what to expect. However, the disadvantages of random values are the challenges to ensure the fair distribution of parameters-values and stable strength of coverage. As a result, it could lead to some biased outputs. To cope with these disadvantages, the random willingness values were classified into three intervals [0.8, 1], [0.3, 0.7], and [0.0, 0.2] (see Section 3.3.3 and Figure 12 for more details).

Regarding EMS optimisation for multi-users, EMS was applied for four groups; three groups included five users while the last group included the whole community. With

respect to willingness in multi-user scenarios, EMS was applied for all the four groups of multi-user scenarios considering a variant willingness to individual users. This experiment highlights how the efficiency of an EMS can be affected by the willingness of users to accept the proposed power shifts. The output load profiles obtained by the EMS considering users' willingness was significantly optimised compared to original load profiles without rescheduling energy consumption. As a result, the performance of the proposed EMS algorithm could have better optimisation results even though the users have varying willingness values. The evaluation results of the proposed system are explained in the following sections.

It is known from the literature that PAR reduction leads to efficient electric usage of power systems (Liu et al., 2014; Lundén et al., 2013; Soares et al., 2014). Soares et al. (2014) reported that the power optimisation percentages of PAR reduction were between 0.5% and 5%. In general, EMS could be run to optimise the power usage of individual R-users or multi- R-users (Shin et al., 2017). In this section, the proposed EMS algorithm was evaluated in several aspects—the single user scenario and the multi-user scenario, both considering users' willingness. Several aspects of evaluating the proposed EMS were applied to demonstrate the effectiveness of the EMS in variant scenarios. In addition, testing these aspects conclude the preferred life circumstances for better PAR reduction. The output results show the optimisation

average of the load consumption by PAR reduction was between 9.85% and 12.32%, and 7.5% and 16.25% for the single user scenario and the multi-user scenario, both considering users' willingness, respectively. However, the single user scenario, considering user's willingness, sometimes had worse results compared to the original power usage profile. These worse results in the optimised power usage profile happened as a consequence of the willingness scenario concept, which gives R-users the opportunity to randomly change their preferences of the shiftable appliances, as previously explained in the willingness proposed system, $Apply_SHF_List = Random.Select(x_{n,s}^{ct}, Na_allowed_Req)$ in Section 3.3.3. This random change of R-users' preferences could vary compared to original R-users' choices. Therefore, the PAR of the optimised power usage profile could be slightly increased in the single user scenario, considering user's willingness. The following discussion is organised as follows: EMS' impact in single R-users scenario, the high power usage issue of particular R-users' appliances, different R-users' preferences' impact on optimisation percentage for exactly the same R-user load profiles and willingness values, and, finally, EMS community-based impact in multiple R-user groups.

Let us now turn to test the proposed EMS for single users with the willingness scenario. To analyse the impact of the willingness value, this value was assigned to

15 R-users in different group scenarios. These different groups helped with analysing the performance of the proposed system in the same R-users but different communities based on the combination of these same R-users. The first three scenarios composed of dividing the R-users into three groups of five R-users in each group. The last group composed of all the R-users with the same load profiles but in different willingness values compared to the previous three groups. The last 'all community' group was used to present the difference in optimisation value of the same R-users but with different willingness values and was also used to compare the optimisation average of this group in EMS in single users to the optimisation average of the same group in EMS in the community-based solution. Table 7 shows the breakdown of the PAR optimisation results according to all the R-users, who were divided into four groups. The influence of willingness value is a somewhat counterintuitive factor to the PAR optimisation of all users. Generally, high willingness value means better PAR optimisation for numerous R-users of all 30 tested scenarios. However, user-3 and user-5 of group-1, user-3 of group-3, and user-5 in the 'all community' group had considerably high willingness values of 0.75, 0.98, 0.9, and 0.88, respectively, but their PAR optimisation was not as high as expected. This resulted in these users having a high number of failed shifting requests because of the high power usage of the appliances of these requests. The

failed request counters for these users were 56, 260, 365, and 260 requests for user-3 and user-5 of group-1, user-3 in group-3, and user-5 in the whole community group, respectively, as will be explained in detail later (see Table 8).

Table 7 The breakdown of PAR optimisation results for single users with willingness

Group ID	User ID	PAR before optimisation	PAR after optimisation	Willingness value	Willingness average	PAR average before optimisation	PAR average after optimisation
Group-1	User- 1	1.85	1.43	0.76	0.64	2.11	1.85
	User- 2	2.24	2.24	0.04			
	User- 3	2.36	1.76	0.75			
	User- 4	2.36	2.05	0.66			
	User- 5	1.76	1.79	0.98			
Group-2	User- 1	1.83	1.67	0.19	0.21	2.13	1.92
	User- 2	1.93	1.83	0.19			
	User- 3	2.18	2.06	0.29			

	User- 4	2.1	1.98	0.21			
	User- 5	2.59	2.04	0.18			
Group-	User- 1	1.69	1.35	0.58	0.67	1.85	1.66
3	User- 2	1.78	1.42	0.98			
	User- 3	2.02	2.02	0.9			
	User- 4	1.67	1.46	0.3			
	User- 5	2.07	2.07	0.58			
All	User- 1	1.85	1.48	0.86	0.45	2.03	1.82
commu	User- 2	2.24	2.05	0.69			
nity	User- 3	2.36	2.2	0.31			
	User- 4	2.36	2.22	0.29			
	User- 5	1.76	1.79	0.88			
	User- 6	1.83	1.53	0.88			
	User- 7	1.93	1.58	0.96			
	User- 8	2.18	1.96	0.15			
	User- 9	2.1	1.88	0.18			
	User- 10	2.59	2.18	0.41			
	User- 11	1.69	1.46	0.3			
	User- 12	1.78	1.72	0.02			

User- 13	2.02	1.71	0.32
User- 14	1.67	1.65	0.14
User- 15	2.07	1.93	0.31

Moving on now to consider the effects of the willingness value and high power usage of particular R-users' appliances to the group optimisation percentages. The correlation between optimisation percentage and the willingness average values of each group was tested and it was found that this correlation is negligible. For example, the optimisation percentages of group-1, 2, 3, and 'all community' were 12.32%, 9.85%, 10.27%, and 10.34% and the willingness averages were 0.64, 0.21, 0.67, and 0.45, as illustrated in Table 7. Therefore, increasing the willingness average of each group led to increasing the optimisation percentage for all experimented groups. Nevertheless, although group-2 had low willingness, their optimisation ratio was close to group-1's, which had around three times higher value in the willingness average. The first reason is that the optimisation percentage depends also on how much power (kwh) of the community will be shifted during the optimisation. For example, even if the willingness average is low for a community composed of crowded users with high possible shiftable power usage, the optimisation percentage will be high. The second reason is even if the willingness

average is high, such as 0.67 for Group-3, as in Table 7, but the proposed EMS found that there is a high ratio of failed shifting requests for the R-users because of the high power usage of the R-users' appliances, the optimisation ratio is minimised. To study the impact of the number of failed requests because of the high power usage appliances of the R-users in group-3, the number of these requests of each R-user in group-3 was found. The results are 62, 0, 365, 6, and 0 for users 1,2,3,4, and 5, respectively, as shown in Table 8. Obviously, R-users with high willingness value increase the willingness average of the overall group; however, high failure requests for a number of the same R-users in the group decrease the optimisation percentage. For example, user-3 in group-3 had a high willingness of 0.9, which pushed up the willingness average value of this group, but the percentage of the failed shifting requests of this user was very high at about 98.63%. As a result, the optimisation percentage of this group decreased.

Before proceeding to examine the community-based with willingness aspect for the R-users, it is necessary to define the effect of the willingness value and failure requests number to the PAR optimisation of R-users in all groups. Using the suggested proposed system, the impact of the willingness value did not increase the PAR of the new load profiles compared to the original load profiles over all R-users, even though the PARs of optimised load profiles of R-users with low willingness

value were not increased. However, few R-users had high willingness value with low PAR optimisation. The failure shifting requests number had a clear impact on the load optimisation of a few R-users. The total number of shifting requests for all R-users in addition to the total number of failure shifting requests failure was found. Table 8 presents the experimental data on the total number of shifting requests and users' failure shifting requests during a day. User-5 in group-1, user-3 in group-3, and user-5 in the whole community group had high failure shifting request percentages, which were 94.2%, 98.63%, and 94.20%, respectively. As a result, these R-users had a high willingness value to optimise their power usage, as in Table 7, which are 0.98, 0.9, and 0.88 of user-5 in group-1, user-3 in group-3, and user-5 in the whole community group, respectively. Unexpected low optimisation occurred, as the new PARs of the optimised load profiles of user-5 in group-1 was slightly increased by 0.03 from 1.76 to 1.79. User-3 in group-3 kept the same original PAR without any improvement at 2.02, and the new PAR of the optimised load profile for user-5 in the 'all community' group was slightly increased by 0.03 from 1.76 to 1.79. The slight increase of the PAR in the optimised load profile of user-5 in group-1 and user-5 in the 'all community' group happened because few of the high power usage appliances shifting requests were shifted. This led to the PAR increasing. This happened during the learning process time of the optimised algorithm to recognise

these were high power usage appliances and they should be prevented to be shifted. Preventing shifting requests for high power usage appliances successfully occurred, as aforementioned. For example, the failure shifting requests percentages were 94.2%, 98.63%, and 94.20% for the user-5 in group-1, user-3 in group-3, and user-5 in the 'all community' group respectively, as in Table 8.

Table 8 The total number of shifting requests and users' failure shifting requests counter during a day

Group ID	User ID	shifting requests counter	Failure shifting requests counter
Group-1	User- 1	430	0
	User- 2	214	0
	User- 3	306	56
	User- 4	293	0
	User- 5	276	260
Group-2	User- 1	330	0
	User- 2	250	0
	User- 3	298	0
	User- 4	269	0

	User- 5	301	0
Group-3	User- 1	431	62
	User- 2	324	0
	User- 3	370	365
	User- 4	262	6
	User- 5	384	0
All	User- 1	430	0
communit	User- 2	218	0
y	User- 3	306	18
	User- 4	293	0
	User- 5	276	260
	User- 6	330	0
	User- 7	250	0
	User- 8	298	0
	User- 9	269	0
	User- 10	289	0
	User- 11	436	36
	User- 12	324	0
	User- 13	365	8

User- 14	262	0
User- 15	378	0

On the other hand, analysing the influence of the failure request number with regards to different users' preferences in the same group, one group with the same load profiles and willingness values but with varied preferences was chosen for this purpose. The R-users' preferences impact the aggregated failure percentage of the group, as a result, the PAR optimisation percentage of the group was also affected. The same R-user load profiles and willingness values of group-3 were experimented on through three different cases of random preferences for shiftable appliances during a day. This day had a 10-minute resolution. This was applied by the *Receiving_R-user_preferences* step, which is previously described in Section 3.3.2. The random samples and permutations function in R programming software was used to provide the R-users with random preferences. This function took a sample of the specified shifting requests from all shifting requests using either with or without replacement. Table 9 explains the average of failure shifting requests and the average of optimised PAR of Group-3 users. Clearly, the cases with preferences that

led to a high average of failure of shiftable requests resulted in low optimisation percentage or higher PAR.

Table 9 The average of failure shifting requests and the average of optimized PAR through the same R-users in different appliance preferences

Case number	PAR optimisation	Before Unresponsive average	PAR After optimisation
Case-1	1.85	0.22	1.55
Case-2		0.23	1.59
Case-3		0.27	1.64
Case-4		0.37	1.66

Another important aspect of evaluating the proposed EMS algorithm is the performance of this algorithm in a community of multi-users with willingness. This study includes groups 1, 2, 3, and 'all community', which have been previously defined. To analyse the community aspect compared to single R-user optimisation, the same previous R-user load profiles in the single R-user scenario with the exact same willingness values optimised their power usage as a community. This implementation method considered the power usage profiles of all R-users whenever there was a shifting control decision. This decision was based on the 10-

minute monitoring of all R-users' power usage in the community, whether there was or was not a need for shifting. Obviously, all four groups of R-users showed better PAR optimisation percentages in a community-based solution, as in Table 10. Comparison results of the power usage of R-users who have individually optimised their power usage without considering the power usage of other R-users in the same community are illustrated in Table 11. It is clear that all groups performed better in the community-based solution. This better optimisation was achieved using the energy management algorithm for shifting the load of shiftable appliances. By combining the shiftable power load of all shiftable appliances, considering peak times of all R-users before making a shifting decision for each individual appliance of any R-user led to better PAR results. The optimisation ratio for each group depended on the willingness value and the failure percentage, which are previously explained.

Table 10 Community-based optimisation of all groups with the individual willingness values of all R-users

Group ID	User ID	PAR before optimisation	PAR after optimisation	Willingness value	Willingness average

Group-1	User- 1	2.11	1.81	0.76	0.64
	User- 2			0.04	
	User- 3			0.75	
	User- 4			0.66	
	User- 5			0.98	
Group-2	User- 1	2.13	1.97	0.19	0.21
	User- 2			0.19	
	User- 3			0.29	
	User- 4			0.21	
	User- 5			0.18	
Group-3	User- 1	1.85	1.64	0.58	0.67
	User- 2			0.98	
	User- 3			0.9	
	User- 4			0.3	
	User- 5			0.58	
All community	User- 1	2.03	1.7	0.86	0.45
	User- 2			0.69	
	User- 3			0.31	

User- 4	0.29
User- 5	0.88
User- 6	0.88
User- 7	0.96
User- 8	0.15
User- 9	0.18
User- 10	0.41
User- 11	0.3
User- 12	0.02
User- 13	0.32
User- 14	0.14
User- 15	0.31

Table 11 Comparison of the PAR optimisation with and without a community-based solution, considering R-users' willingness

Group ID	PAR average before optimisation	PAR average after optimisation for single users	PAR average after multi-users	Optimised percentages for single users	Optimised percentages for multi-users	Willingness value for average for each group
Group 1	2.11	1.85	1.81	12.32%	14.21%	0.6
Group 2	2.13	1.92	1.97	9.85%	7.5%	0.2
Group 3	1.85	1.66	1.64	10.27%	11.35%	0.6
All community	2.03	1.82	1.7	10.34%	16.25%	0.4

Empirically, it seems the community-based solution is the most effective energy management optimisation in all scenarios considering the willingness value of R-users to participate in the EMS algorithm. Applying the EMS algorithm in single and multi-users without willingness demonstrates that most load profiles of the R-users are optimised. With regards to considering the R-users' willingness, the community-based optimisation is a considerably higher PAR optimisation of the majority tested group scenarios. Group 2 shows less improvement in the community-based solution than single-user optimisation. This could be because of the low willingness average of the R-users (0.21 in the current study). That could lead to the groups with low

willingness values preferring to optimise their power usage individually rather than community-based optimisation. It seems the willingness average of an R-users group is linked to PAR optimisation. The failure request number plays a significant factor in decreasing the optimisation percentages of R-users and the overall group of users. It has also been noted that the average load of any given load profile might impact the failure request number.

4.4 Mathematical modelling system experimental methodology and results

The current investigation involved optimising power consumption considering the proposed system, which is involved in the system model for mathematical optimisation, as explained in detail in Section 3.4. In this experimental work, the users' power usage profiles were loaded from the dataset provided by Cambridge Architectural Research (CAR) and the Department of Energy and Climate Change (DECC) in the U.K. (Jason Palmer et al., 2013) (for more details, see Section 4.1). Each load profile includes 24-hour monitoring at the appliance level with a 10-minute granularity. On account of the wide variety of power consumption values recorded from individual appliances' meter readings, it is impossible to directly adopt real-time meter readings into the proposed mathematical model constraints. These power consumption variety values happened for two main reasons. First, more than one

appliance was merged in one meter reading record, such as cold appliances. Second, there was different functionality during the operation, such as changing the temperature during washing and drying for a washing machine. As a result of these data collection limitations, there are two ways to process the collected real-load profiles depending on the load type, which is either non-shiftable or shiftable. For non-shiftable loads, the meter readings are considered, as they are the original form of the energy management system. For shiftable load, the meter readings need to be regularised into single power usage values for individual shiftable appliances. This individual on/off power usage value was preferred in the previous work (Esther and Kumar, 2016; Rastegar et al., 2012; Setlhaolo and Xia, 2016).

To regularise the shiftable load, which recorded a wide range of power usage meter readings, such as readings ranging from 0 to 300W in one appliance during a day, a statistical methodology suggested by Md Diah and Ahmad (2012) was used. Md Diah and Ahmad (2012) proposed several steps for data processing, such as using a histogram to define how good the data sample is, applying descriptive statistics to identify a dependent and independent range of data transformation, applying data transformation, applying validity checks, and applying model validity checks for aggregated samples. In the experiment, this methodology was used to understand the individual usage pattern and conclude a regularisation procedure that could

automatically adjust the load data of all shiftable appliances in all R-users into an accepted form by the mathematical model. The details of this procedure are discussed in 3.4.3 section.

Prior to undertaking the evaluation of the proposed mathematical model and overall proposed system, a validation process was applied to ensure the regularised power usage consumption was close to the real power consumption profiles. This, in turn, allowed for results to generalise this process for all R-users' shiftable appliances and accurate evaluation for the proposed mathematical model. Table 12 presents a comparison between measured and regularised the aggregated power usage of individual shiftable appliances during a day. The 'measured power' and 'regularised power' columns are measured in watts per day. From the 'percentage change' column, it is clearly shown the regularised load profile is close to the real measured load profile.

Table 12 Comparisons between measured and regularized power usage of shiftable appliances of one R-user in a day

Appliance	Measured Power	Regularised Power	Percentage Change
App- 1	6759	6810	0.75%

App- 2	11965	12086	1.01%
App- 3	583	594	1.89%
App- 4	12354	12564	1.7%
App- 5	47364	47628	0.56%
App- 6	1779	1843	3.6%
Average			1.5%

For more validation of the regularisation procedure's accuracy in producing the usage pattern of overall R-user power load profiles (shiftable and non-shiftable) during the course of a day in 10-minute resolution, Figure 21 presents substantially close power usage patterns between the measured and regularised power usage of the shiftable and non-shiftable load.

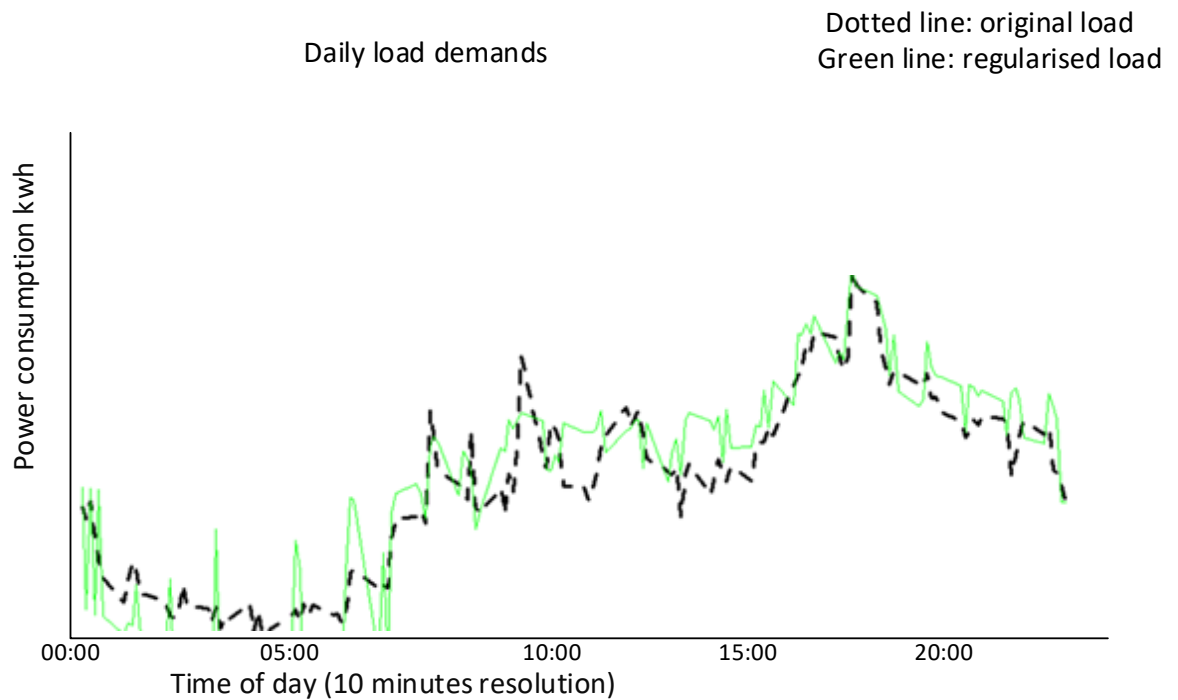

Figure 21 Overall power usage of shiftable and non-shiftable appliances for 24 hours for R-users.

Considering the main evaluation metric to measure R-users' optimised load profiles of this study, which is the PAR, further evaluations were applied to show that this metric has no significant difference between the PAR values of the measured and regularised overall power usage, shiftable and non-shiftable, in a day. Table 13 presents the PAR values before and after the regularisation process for different R-users. Standard deviation values present how the close spread of the PAR values of the regularised load profiles compared to the PAR values of the original load profiles.

It is clearly shown that the standard deviation was considerably small between the PAR values of all R-users before and after the regularisation.

Table 13 PARs before and after the regularization procedure for different R-users

User ID	PAR before regularisation	PAR after regularisation	Standard deviation
User- 1	1.85	1.83	0.01
User- 2	2.24	1.84	0.28
User- 3	2.36	1.91	0.31
User- 4	2.36	1.98	0.31
User- 5	1.76	1.81	0.03
User- 6	1.83	1.74	0.06
User- 7	1.93	1.76	0.12
User- 8	2.18	1.9	0.19
User- 9	2.1	1.89	0.14
User- 10	2.59	1.86	0.51
User- 11	1.69	1.71	0.01
User- 12	1.78	1.72	0.04
User- 13	2.02	1.8	0.15

User- 14	1.67	1.66	0.00
User- 15	2.07	1.86	0.14

There is an exceptional difference in four R-users' PAR values (User-2, 3, 4, 10). After studying their shiftable load during the regularised process, it was found that there was no significant difference in the aggregated load of individual shiftable appliances in a given day, which means the regularisation process was applied properly for them. However, the power consumption of the majority of shiftable appliances was significantly increased during the same period in the given day. Aggregating all this increased usage in the same specific period caused a slight difference in the PAR values before and after the regularisation.

An evaluation of all R-users' load profiles as a community was applied. Table 14 illustrates the PAR results of all community's R-users before and after the regularisation process. It shows the regularised load profiles were in good agreement with the measured load profiles. Therefore, utilising the regularised load profiles to feed the proposed mathematical model and algorithms was applicable. The evaluation results of the proposed mathematical modelling system are explained in the following sections.

Table 14 The PAR results of an R-user community before and after the regularization process

User ID	PAR before Regularisation	PAR after Regularisation	Standard deviation
allcommunity-users	2.02	1.7	0.16

After the above validation of the regularisation procedure was carried out, it was time to evaluate the proposed MINLP mathematical model. Liu et al. (2014) and Mohsenian-Rad et al. (2010b) found that the PAR value could be minimised using particular optimisation mathematical models and algorithms. The mathematical model and algorithm suggested by Mohsenian-Rad et al. (2010b) led to reducing the PAR from 2.1 to 1.8, and the power cost reduction was \$6.87 per day for a single user. However, synthetic data was used to evaluate their suggested solution. In this work, a real data set was used, composed of R-user power profiles measured during the course of a day with a granularity of $\Delta t = 10$ minutes. A valid regularisation procedure of shiftable appliances, as explained earlier, was applied for this data set to make it suitable for the solver. Optimised results of R-user power profiles obtained by the proposed MINLP were compared with the actual R-user power profiles without optimisation. The proposed MINLP model was experimented on in two different

scenarios. First, the EMS incorporated with the proposed MINLP of individual R-users was applied to R-users' load profiles. Second, EMS in the community-based server incorporated with the proposed MINLP model was applied. To obtain a clear comparison between single and community scenarios, this community was composed of the same previous R-users with the equal load profiles used in the previous individual R-user scenario. Note that each R-user consumed the same amount of overall daily aggregated load in both scenarios. The proposed MINLP improved the R-users power usage scheduling more efficiently when it was running on the community-based server, compared to the same proposed MINLP running on individual EMSs. Table 15 shows the results obtained by applying the proposed MINLP model to 15 R-users. In these results, it can be clearly seen that all individual R-users extremely reduced their PARs via individually applying the proposed MINLP model in their EMSs. The average overall PAR values of all individual R-users was minimised in 41.5% from 2.02 to 1.18.

Table 15 The results were obtained by applying the proposed MINLP model to 15 R-users

ID	PAR before optimisation	PAR after optimisation
User-1	1.85	1.16

User-2	2.24	1.32
User-3	2.36	1.17
User-4	2.36	1.25
User-5	1.76	1.22
User-6	1.83	1.12
User-7	1.93	1.23
User-8	2.18	1.25
User-9	2.1	1.09
User-10	2.59	1.28
User-11	1.69	1.13
User-12	1.78	1.16
User-13	2.02	1.14
User-14	1.67	1.13
User-15	2.07	1.14
Average	2.02	1.18
All community users	2.02	1.01

It is necessary to understand how the PAR was reduced by individual R-users' power consumption patterns during the course of a day, based on Δt time sampling, which

was 10 minutes in this study. Three individual R-users were chosen to demonstrate the MINLP model's impact at each time sample, Δt , in the day.

Figure 22 compares the load profiles patterns of three different R-users who were selected, user 1, 2, and 15, during a 24-hour period to compare their power usage pattern with and without applying the proposed system.

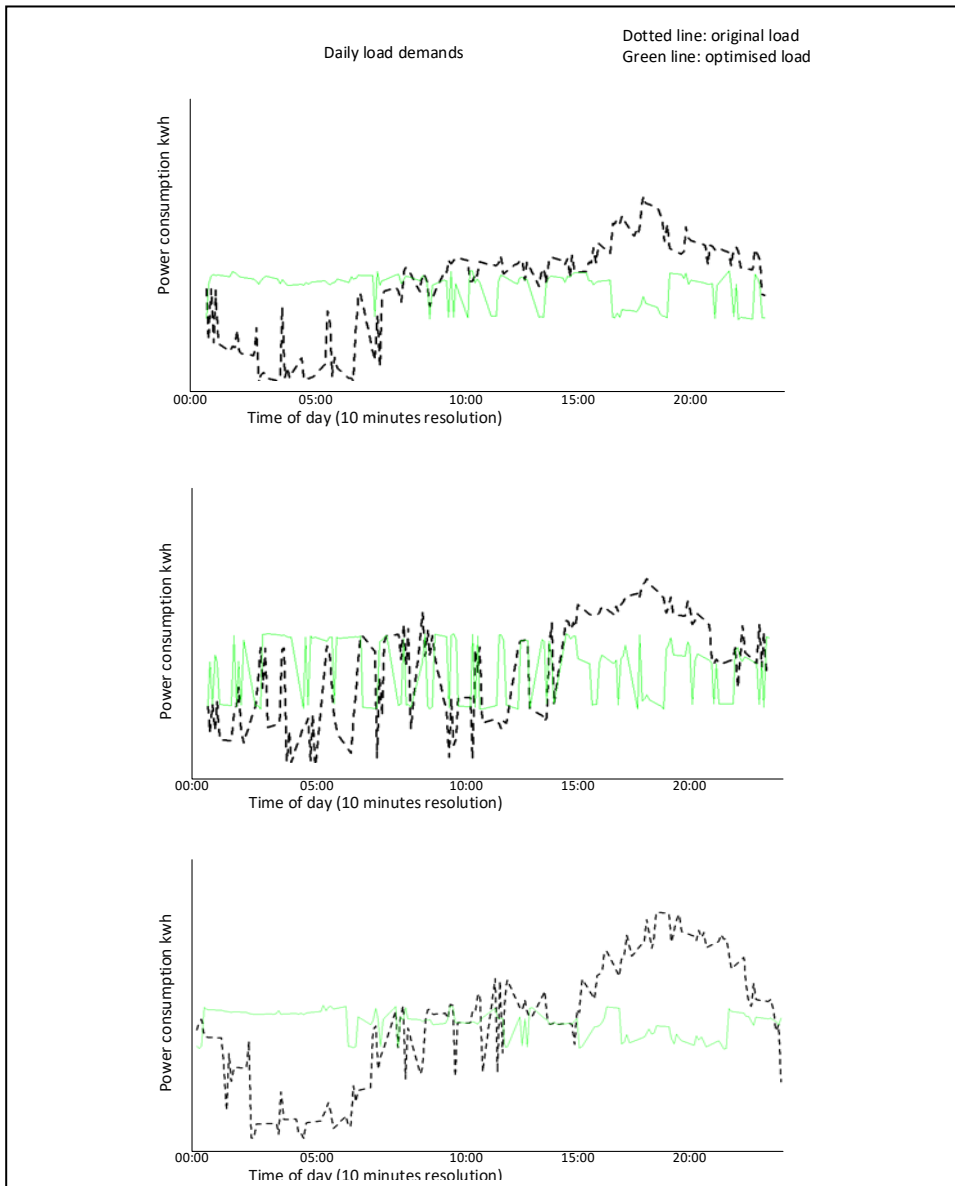

Figure 22 Comparison of the load profile patterns of three different R-users User-1, 2, and 15 24 hours before and after applying the proposed system

It can be observed that the optimised load profiles considerably increased during the period between 00:00 to 07:00 am for all R-users compared with the original un-optimised load profiles. This indicates a desirable usage pattern for both generator utilities and R-users because increasing the load usage at this time prevents wasting generated power during this period, which is advantageous for the provider and gives cheaper prices for power usage to R-users. The optimised load profiles of all R-users during the mid-peak period, between 11:00 am to 03:00 pm, were not affected compared with original un-optimised load profiles. The optimised load profiles of all R-users during the peak period, which is between 05:00 pm to 09:00 pm, considerably decreased compared with original un-optimised load profiles. The new load patterns were more desirable in both aspects: PAR and cost reduction.

With respect to evaluating the proposed stage in a community-based scenario, Table 15 presents that the optimised load profile reported a significantly lower PAR value than the original load profile of overall R-users in the community. The average overall PAR of all R-users in this community was minimised by 50% from 2.02 to 1.01. These are extremely good results but may have been positively influenced by the regularisation process. However, the regularised load profiles were very close to the measured load profiles, as previously presented in tables 12-15. To demonstrate how the optimised load usage pattern of this community improved compared to the

original un-optimised usage pattern during the day, Figure 23 presents the load profiles before and after applying the MINLP model of all R-users in the community.

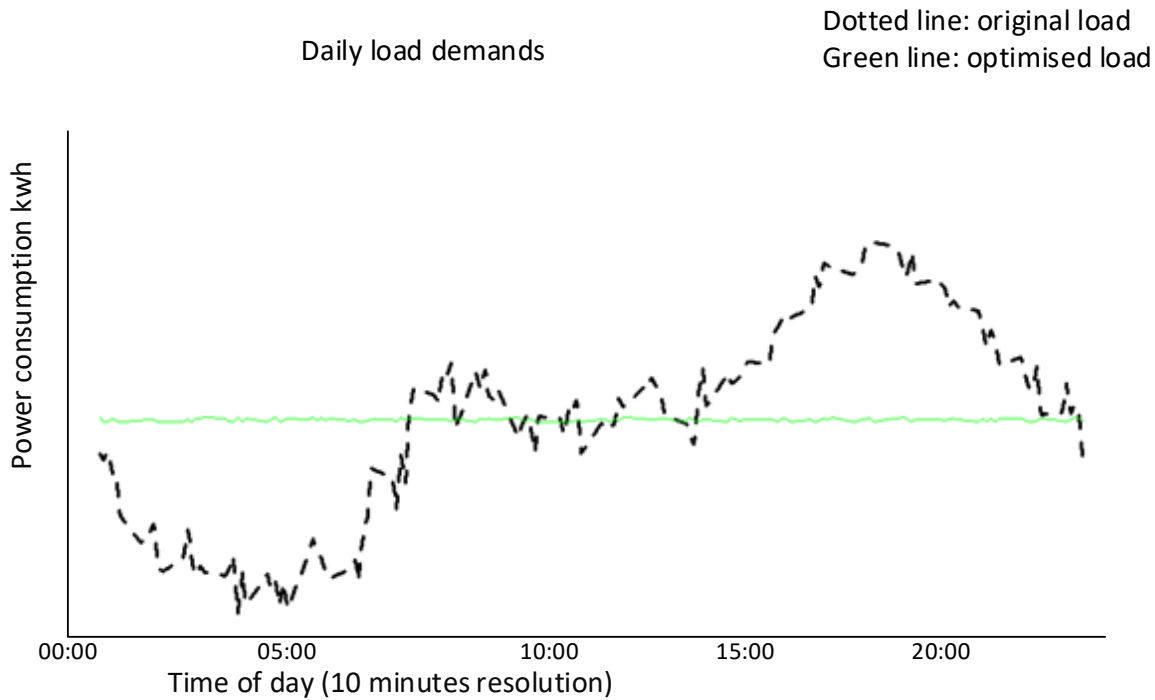

Figure 23 Load profile patterns of all R-users in the community during 24 hours before and after applying the proposed system

Based on the limited available data set of load profiles, there are two main factors that were not explored in this study to evaluate the proposed system performance as in real-time conditions. First, the appliance functionality cycle in some cases was not guaranteed in the optimised load profile. Second, the meter readings of more than one appliance were, in some cases, merged into one record. These results, 162

nevertheless, suggest applying the MINLP model in EMSs can provide substantially optimised load profiles for solving the RLSP problem in smart home communities.

4.5 Conclusion

This chapter described a set of experiments aiming to evaluate the proposed novel energy management systems at both the single and the community level. The efficiency of the methods was benchmarked using the optimisation percentages and PAR reduction in each of the proposed systems. The results proved the proposed algorithms have been implemented successfully and delivered substantive improvements.

This chapter also analysed the real-time load profiles' issues and solutions for the proposed stages. The objective of considering real-time load profiles was to verify all the proposed stages were providing optimised load profiles in 10-minute resolutions. These output profiles agreed with the PAR minimisation in any given scenario. The results show that all the proposed systems had good agreements with the PAR minimisation.

5. Communication/ overall architecture

The concept of optimising the scheduling of power consumption in the context of variable energy pricing requires minimisation of PAR using energy management systems. These systems or the stages to improve these systems need to exchange power usage profiles and control information among households, appliances, gateways, and outdoor servers. As a result, any proposed stage to improve the energy management systems should be structured in a framework that efficiently and effectively connects the energy consumption components (for more details on these components, see Section 2.1). This chapter proposes theoretical communication architecture for energy consumption components. This chapter also discusses communication principles, information required from appliances, and single versus community-based communication requirements. The aim of the proposed framework is to integrate the proposed three stages into a typical smart home infrastructure to minimise PAR.

5.1 General communication architecture for scheduling methods of optimising power consumption

In chapters 3 and 4, three novel stages for the energy management system were explained and experimented on. To produce a framework of integrating these suggested three stages in the real world, the following aspects must be defined:

communication principles, information required from appliances, and single versus community-based framework requirements. The aim of this framework is to integrate the proposed three stages into a typical smart home infrastructure to minimise PAR. The energy consumption entities, such as smart homes, energy distribution networks, and energy suppliers are explained in detail in Section 2.1. To provide networking or/and communication among R-users appliances and outdoor servers, two types of connection are required. Figure 24 shows the overall communication architecture between household appliances and the community-based server. First, there is household domain networking to connect sensors, devices, and domestic appliances to the smart meter or the smart gateway. This gateway collects necessary data from the connected sensors and sends it to the outdoor control server. Second, there is the community-based domain, which is a communication platform between R-user gateways and the outdoor control sever. Next, the networking types in both domains are discussed.

In the first household networking domain, there are two types of networking and/or communication: wired and wireless networks. To apply the wired networking, there are several protocols under PLC (power line communication) technology such as X-10, INSTEON, HomePlug, and LonWorks. The main advantage of using PLC is using the number of electrical outlets, which are already available in a house. In

wireless networks, there are several protocols such as Bluetooth, 802.15.4/ZigBee, and Z-wave. With regard to the second community-based networking domain, it is also divided into two main communication types: point-to-point and mesh networks. A point-to-point network connects the households' gateways by authorized entities, employing a third-party telecommunication network via passwords. Point-to-point networking is useful for specific geographic areas where there is a limited number of households and multiple energy providers. Mesh networking is composed of a group of household gateways forming a meshed radio network to communicate with each other, as previously defined in Section 2.1.2. In mesh networking, each household's gateway works as a signal repeater and sends data to the electric network access point, which, in turn, sends it to a community-based server via a coherent communication network (Cheng and Kunz, 2009; Zunnurain et al., 2018).

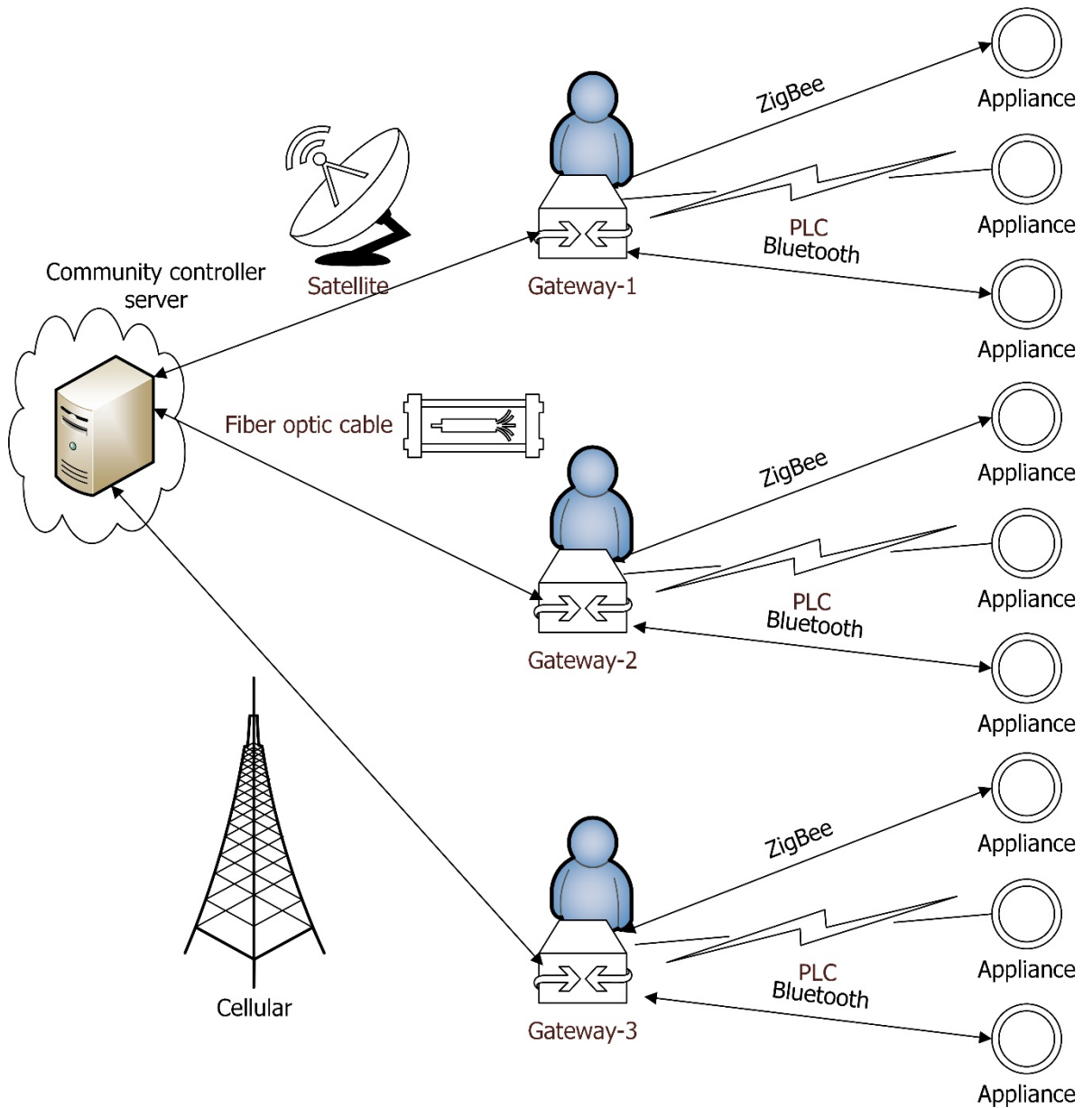

Figure 24 Overall communication architecture between household appliances and a community-based server

The networking of both household and community-based domains can be classified into three main networks: home area network (HAN), neighbourhood area network (NAN), and wide area network (WAN). First, HAN is used to connect household appliances, such as gateways, distributed renewable energy sources, and plug-in electric vehicles. HAN requires low bandwidth and it is a cost-effective network platform for communicating between household appliances and the gateway. HAN informs consumers about energy consumption and other profiles via a web interface or internal display. Second, neighbourhood area networks (NANs) interconnect multiple HANs and communicate the collected information to wide area networks (WANs). They are used for bi-directional communication between several household gateways and the community-based server. Third, WANs, which serve as the communication backbone to connect several NANs to a bigger community server, are composed of multiple small geographical regions of individual community-based servers. The fibre optic cable, cellular networks, microwave, and WiMAX are some popular WAN system platforms.

Regarding the preferred network measurement performance, such as bandwidth, latency, and data rate, each of the two networking domains has different requirements. Regarding the household domain networking, it can be adopted with low bandwidth, low power, and short-distance network technology. A wireless HAN

system, such as ZigBee, Bluetooth, or Wi-Fi is preferable compared to wired networks. Comparatively less bandwidth per appliance/node, such as 14-100 Kbps, and latency time of 2-15 s are required for wireless HANs (Fang et al., 2008). In terms of the community-based domain, PLC, the digital subscriber line (DSL), and cellular networks are preferred to serve as a communication medium between household gateways and community-based servers. PLC was chosen for its compatibility with the current power grid infrastructure and secure data transmission. Nevertheless, it suffers from low bandwidth, the medium is harsh and noisy, and it is sensitive to the wiring distance between transmitter and receiver. The second example of networking between household gateways and community-based servers is DSL, which uses wires from the voice telephone network. DSL is used for numerous reasons, such as widespread availability and low-cost and high-bandwidth data transmissions. However, because of the communication cable requirements for installing DSL, it is not suitable for rural areas. The third example of networking between household gateways and community-based servers is cellular networks. It is the preferred choice because the widespread and cost-effective advantages make cellular communication one of the leading communication technologies. The only disadvantage of cellular networks is that services of cellular networks are shared by the customer market and this may result

in network congestion or lowering of network performance in emergency situations. As a result, energy providers use WiMAX for its security protocols, smooth communication, high data speeds, and an appropriate amount of bandwidth and scalability. Nevertheless, WiMAX is not as widespread as fibre optics, meaning the installation costs are expensive (Zunnurain et al., 2018).

In terms of data content, the required inputs and outputs data and signals for smart appliances to operate and communicate automatically with the proposed three energy management stages are: 'time' for appliance operation at each time slot, 'power' for amount of power usage in watts at the given time, and 'status' for indicating if the appliance is shiftable or essential (non-shiftable), as shown in Table 16. These data contents are fundamental for all three energy management systems, however, regarding willingness and mathematical modelling, more data contents are required. For willingness, households' willingness and preference values are added to fundamental data contents. Households' willingness values are used to provide the EMS willingness system with the exact willingness value of individual households, which reflect the incentive level of the power load optimisation to each household to allow an automatic system to control the households' power usage. Household preference values are useful to reflect a real-world scenario, which is that even though two households have the same willingness values they probably prefer

to shift different appliances at each given time. This real-world scenario is described that different households' prefer to choose different types of appliances to be shifted, and for the same households themselves, they may prefer different appliances to be shifted from one time to another. For example, the households' preferences may vary between working days and weekends or between summer and winter. For mathematical modelling, continuous (non-linear) and linear indications are added accordingly to essential and shiftable appliances, respectively. These indications are useful to enable the mathematical model in EMS to suitably apply the regularisation process for only shiftable appliances then apply the mathematical optimisation process by considering the indication of essential appliances as non-linear. The appliances-id and R-users-id are significantly needed for community-based solutions to enable the server to access a specific appliance for a particular R-user.

Table 16 A sample of the data power profile contents.

Time	Power	Status	Willingness value	Preferences	Linear (for essential appliances)	Continuous (for shiftable appliances)	R-users-id	Appliances-id
05:00	52.3 W	shiftable	0.45	Yes	No	Yes	User-1	App-6

Manual appliance control is unattractive to households and inefficient for managing loads when the energy generation cost is high or network condition is jeopardized. The proposed three stages, which are discussed in Chapter 3, can make automatic decisions on behalf of households to consume electricity in cost-effective and efficient ways while helping the energy providers maintain a balance between generation and demand. These stages are designed in a way that when the power usage leads to peak hours, it shifts the shiftable appliances' load to off-peak hours and only allows essential loads to operate to maintain consumer comfort. Households can pre-set essential and shiftable appliances. The energy providers can send load control signals to the households' gateways for managing the network. The proposed stages also keep the load consumption of individual appliances within the same daily limit before and after optimisation, which, in turn, provides households with the needed power to operate their daily needed appliances for their comfort. However, it will shift the shiftable load running during peak hours. For instance, if a consumer has a high total load during a peak period and turns the coffee maker and microwave on, as the gateway sends information at the 10-minute resolution, the proposed stages will allow higher consumption for a short period while sending the reports (see Figure 25). Hence, the proposed stages take optimal decisions for load

consumption and scheduling based on PAR minimization, which reduces energy costs and network violation.

Assuming households and energy providers chose one of the three novel energy management stages, the households then chose the optimisation scenario, which is either single or community-based optimisation. Figure 25 presents the optimisation control architecture, which is composed of appliances, gateways, community servers, and the proposed stages.

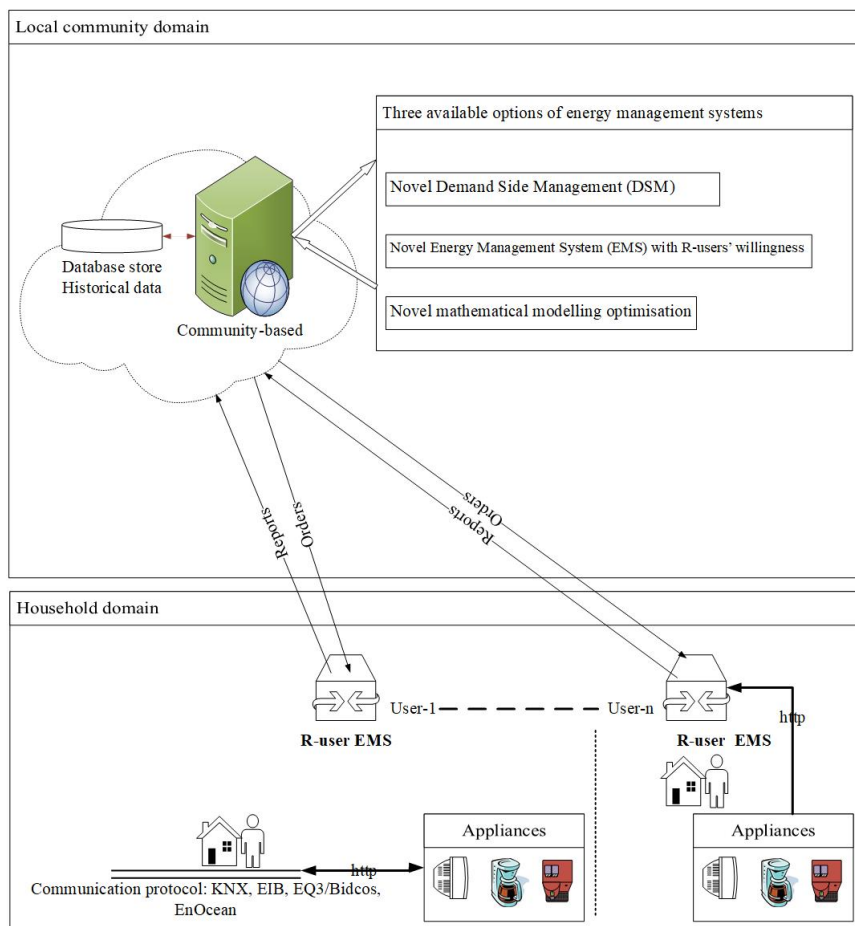

Figure 25 Three available energy management systems for power optimisation

5.2 Conclusion

This chapter proposed communication architecture for linking the proposed three stages for an energy management system, which are described in Chapter 3. The proposed communication architecture connects remote a community server and households' appliances. This architecture is composed of individual households'

smart appliances, household gateways, and a community server. These architecture components are connected using diverse networking and/or communication types depending on the requirements of individual components in this architecture. This proposed architecture aims, first, to reduce the PAR and, as a result, the households' energy costs are reduced. Second, it aims to provide the necessary infrastructure for the energy consumption entities, which are described in Section 2.1, to communicate with each other. Even though it is not a novel infrastructure, however, in the future there should either be a better infrastructure or additional functionalities that could be implemented. Third, it is very human-centric, as it adapts to the R-users' willingness and community aspects.

Generally, choosing a particular communication type can be driven by multiple factors such as required data rate, cost, environmental condition, data type, and network architecture. Therefore, choices among the different types of communication technology can vary and what may fit for one environment may not be suitable for another. Applying appropriate communication architecture has numerous benefits:

- Using diverse networking and/or communication types overcome the challenges raised by information monitoring and management in traditional

electrical networks, which is typically limited to distribution networks that distribute electrical power in a city to individual consumers.

- Using the communication architecture helps the smarter grid to be equipped with state-of-the-art information and communication technologies (ICT) and smart devices, such as smart meters, wireless sensor nodes, and load balancing through real-time demand-side management, pervasive computing, sensing devices, broadband communication, and intelligent management techniques.
- Using the communication architecture and wireless sensor nodes along with actuator networks can be useful to give access to remote sites and places where human intervention is not possible.
- Such communication technologies have the potential to significantly improve the efficiency, effectiveness, reliability, sustainability, and stability of the electrical grid.

Therefore, the traditional electrical grid is currently undergoing a range of modernization efforts and becoming a smarter grid. Using the presented networking and/or communication types, the proposed energy management systems can minimise the undesired power consumption patterns' impact by R-users and, as a

result, reduce the consumption fluctuations by maximising the match between power consumption and generation.

The following chapter provides a summary of the research project including key achievements, limitations, and scope for future work in the energy management systems.

6. Conclusion

This chapter concludes the thesis by highlighting the main achievements of this research, discussing its limitations, and defining future research directions within energy management systems.

6.1 Achievements of the research

The research achieved the aims and objectives stated in Chapter 1. The following points are the main achievements of this research:

- Investigating the domain of home energy management systems and mathematical models, from the perspective of increasing the load demand stability.
- Demonstrating comprehensive literature of existing research in the domain of home energy management systems to explore the aspects of the research problem that the literature has not addressed. These aspects were how the current research deals with a community-based solution for power optimisation, how to produce an energy management system with appliance-by-appliance analyses, and how to evaluate the proposed energy management systems using real-load profiles. After proposing a new energy management system, another aspect in the literature was studied, which focused on R-users' willingness to allow an automatic system to control the

R-users' power usage. The last aspect of the literature covered utilising a mathematical model which gives the optimal scheduling pattern solution, which is better compared to suboptimal scheduling patterns to reduce PAR, which are obtained by algorithm-based energy management systems and depend on how the data load profile is parsed.

- Developing a novel demand-side management (DSM) for optimising power consumption patterns of R-users in single and community-based scenarios. This new DSM focuses on a community-based allocation of power demand for minimising the peak load. In the DSM operation environment, single R-users minimise the PAR of the power system by shifting consumption to off-peak times, but the policy is more effective as a result of considering the community-based nature of the demand.
- Developing a novel energy management algorithm within an energy management system (EMS) to optimise power consumption and to reduce the overall PAR for a community of R-users. Beyond the group optimisation, the algorithm considers the heterogeneous nature of the R-users by introducing individual household values of willingness to save power and have the energy managed. In conjunction with the concept of community energy management and willingness, this second novel system also

highlights the importance of incentives for power-load optimisation to each R-user.

- Developing a novel energy management system for PAR minimisation based on a mixed integer non-linear programming (MINLP) mathematical model automated algorithm. This system was evaluated in both single and community-based R-users' realistic scenarios. Energy management systems (EMS) are a supervisory control tool used in both individual R-user gateways and community-based servers to ensure optimal operation of the proposed mathematical model. The MINLP was formulated to minimise the PAR in single and community-based scenarios through providing orders, which included the optimal power usage patterns of shiftable appliances during a day with a 10-minute resolution.
- The applicability and usefulness of the novel energy management system were demonstrated via three experimental case studies. The first illustrated DSM was used at a strategic level. The second experiment focused on EMS applicability at the operational level, the key aim being to prove the viability and robustness of the EMS algorithm when applied to R-users with different willingness values. These values represent an acceptable level to allow an automated system to control the power consumption of the household. The

third experiment illustrated the applicability of a novel mathematical model to incorporate the energy management system. Conducting a series of experiments using real load profiles aimed at evaluating the effectiveness and the performance of the above-developed energy management systems, a load of each individual user's profile was measured during a 24-hour cycle with 10 minutes resolution. There were 11 types of appliances, which were measured at each time slot of 10 minutes. 144-meter readings associated with 10-minute timeslots for each appliance were analysed and rescheduled based on the implementation of the three novel energy management systems.

Several papers related to the research were presented and published in refereed conferences. As a result, the research was considered as having made positive contributions to the field of energy management systems and specifically in the domain of appliance-by-appliance level and real load profiles with high resolution.

6.2 Limitations of the research project

Despite the research objectives stated above having been met, a number of limitations associated with the project can be identified. The key limitations of the research are summarised as follows:

- The experimental dataset was limited in three main aspects. First, the time slot granularity of meter readings was long (10 minutes). Ideally, shorter time granularity is more accurate for turning on/off decisions by the proposed energy management systems. Second, the appliance functionality cycle in some cases was not guaranteed in the optimised load profile. Third, the meter readings of more than one appliance were, in some cases, merged into one record.
- As far as the energy management algorithm with R-users willingness is concerned, some further improvements could be made. In this thesis, R-users' willingness was provided by users. However, these values could be generated by analysing R-users' load profiles. Considering the number of load profile demands increases, e.g. 1000 R-users load profiles in a 10 minutes resolution, it would take an excessively long time to search for the best one among all possible control actions. Therefore, it would be worth devoting time to finding better search procedures, such as a heuristic search method considering the process of finding R-users' willingness based on user-selectable criteria. Optimisation methods could also be incorporated, such as a genetic algorithm, a simulated annealing algorithm, taboo search,

etc., to improve the speed and effectiveness of the search procedure among the possible result set.

- As far as the energy management algorithms at the operational level are concerned, some further improvements in the wireless communication protocol are recommended to improve the user acceptance level. These improvements could be applied in three main perspectives: system response time, the reliability of transmitting and receiving the control signals, and, finally, the capability of real-time diagnosis and fault detection for both supply equipment and demand devices.
- Finally, other optimal objectives based on economics and environmental concerns could also be integrated into the energy management systems. This would increase the conflicting aspects both in amount and intensity. The problem to be solved becomes multi-objective in nature, with economic, technical, and quality of service aspects all needing to be considered in energy management systems. Using such a multi-objective model, a decision maker should understand the conflicting nature of the various goals and decide on the trade-offs to be made to obtain a satisfactory solution.

6.3 The future of energy management systems

In this thesis, there are still some improvements that need to be made and recommendations for future research.

- The method of predicting electricity load profiles at the residential community level could be applied to different communities. The main challenge of applying this method is the availability of the input data, such as occupancy usage patterns incorporated with real-time prices. This could be improved by generating national representative cumulative distribution functions (CDF) across the country for different groupings and regions, which could be applied by local energy providers.
- In this thesis, all individual appliances were known to the novel energy management systems. Applying these systems to unknown appliances would be a challenge. For instance, the system would be unable to distinguish between shiftable and non-shiftable appliances. This is further challenging when applying an energy management system to household load profiles on a nationwide level. Therefore, using pattern recognition methods and, thereby, segregating the components are needed.

- More load profiles of appliances, e.g. fans, air conditioners, and renewable energy sources have not been included in this thesis. It would be possible for these profiles to be included in future work for more practical solutions.
- As the popularity of on-site distributed generations grows, energy supply becomes more unpredictable and fluctuating. Matching the changeable local demands with this type of supply becomes more challenging than ever before. A new component, such as an SSM (supply side management) algorithm will make the tool comprehensive and integrative by allowing both demand and supply sides to be analysed jointly. The ultimate goals of this decision-making tool are to improve the efficiency of the energy utilisation from distributed generation sources, to decrease unnecessary energy waste, and to increase households' awareness level of energy consumption.

7. References

- Ahmadi, M., Rosenberger, J.M., Lee, W.-J., Kulvanitchaiyanunt, A., 2015. Optimizing Load Control in a Collaborative Residential Microgrid Environment. *Smart Grid IEEE Trans. On* 6, 1196–1207.
- Akter, M., Mahmud, M., Oo, A., 2017. A hierarchical transactive energy management system for energy sharing in residential microgrids. *Energies* 10, 2098.
- Albadi, M.H., El-Saadany, E.F., 2008. A summary of demand response in electricity markets. *Electr. Power Syst. Res.* 78, 1989–1996.
- Albadi, M.H., El-Saadany, E.F., 2007. Demand response in electricity markets: An overview, in: 2007 IEEE Power Engineering Society General Meeting.
- Aldrich, F.K., 2003. Smart homes: past, present and future, in: *Inside the Smart Home*. Springer, pp. 17–39.
- Ali, M., Osama, M., Nadeem, A., Shafique, T., Baig, M.J.A., Zafar, R., Mahmood, A., 2016. Development of DSM based HEMS Model for Energy Management in Smart Grid, in: *Proceedings of 2nd International Multi-Disciplinary Conference*. p. 20.
- An, H., 2014. Main Success Factors for Developing Car-sharing in China. *Blekinge Institute of Technology*.

- Anvari-Moghaddam, A., Monsef, H., Rahimi-Kian, A., 2015. Optimal smart home energy management considering energy saving and a comfortable lifestyle. *Smart Grid IEEE Trans. On* 6, 324–332.
- Avalon Energy Services, 2014. What Does Volatility Look Like? | Avalon Energy® Blog. URL <http://www.avalonenergy.us/blog/?p=867> (accessed 5.7.16).
- Bellido-Outeirino, F.J., Flores-Arias, J.M., Linan-Reyes, M., Palacios-garcia, E., Luna-rodriguez, J., 2013. Wireless sensor network and stochastic models for household power management. *Consum. Electron. IEEE Trans. On* 59, 483–491.
- Borenstein, S., 2002. The trouble with electricity markets: understanding California's restructuring disaster. *J. Econ. Perspect.* 16, 191–211.
- Bouhafs, F., Mackay, M., Merabti, M., 2014. *Communication Challenges and Solutions in the Smart Grid*. Springer.
- Bozchalui, M.C., Hashmi, S.A., Hassen, H., Cañizares, C.A., Bhattacharya, K., 2012. Optimal operation of residential energy hubs in smart grids. *IEEE Trans. Smart Grid* 3, 1755–1766.
- Britz, J., Frey, J., Alexandersson, J., 2014. Bridging the Gap between Smart Home and Agents, in: *Intelligent Environments (IE), 2014 International Conference On*. IEEE, pp. 31–38.

- Celebi, E., Fuller, J.D., 2007. A model for efficient consumer pricing schemes in electricity markets. *Power Syst. IEEE Trans. On* 22, 60–67.
- Chaouch, H., Ben Hadj Slama, J., 2014. Modeling and simulation of appliances scheduling in the smart home for managing energy, in: *Electrical Sciences and Technologies in Maghreb (CISTEM), 2014 International Conference On. IEEE*, pp. 1–5.
- Chen, C., Kishore, S., Snyder, L.V., 2011. An innovative RTP-based residential power scheduling scheme for smart grids, in: *Acoustics, Speech and Signal Processing (ICASSP), 2011 IEEE International Conference On. IEEE*, pp. 5956–5959.
- Cheng, J., Kunz, T., 2009. A survey on smart home networking. Carlet. Univ. Syst. Comput. Eng. Tech. Rep. SCE-09-10.
- Choi, K.-S., Park, Y.-C., Ahn, Y.-K., Jung, K.-M., Hong, S., Chung, H.-B., 2012. Energy Saving System for Home Energy Measurement and Efficient Power Control, in: *Mechanical Engineering and Technology. Springer*, pp. 21–26.
- Congress, U.S., 2005. Energy Policy Act of 2005 (Public Law 109-58, Aug. 8, 2005, 119 Stat. 594). US Congress. URL: <http://www.gpo.gov/fdsys/pkg/PLAW-109publ58>.
- Costanzo, G.T., Kheir, J., Zhu, G., 2011. Peak-load shaving in smart homes via online scheduling, in: *Industrial Electronics (ISIE), 2011 IEEE International Symposium On. IEEE*, pp. 1347–1352.
- DTI, 2002. Energy Consumption in the UK.

- Du, P., Lu, N., 2011. Appliance commitment for household load scheduling. *Smart Grid IEEE Trans. On* 2, 411–419.
- Esther, B.P., Kumar, K.S., 2016. A survey on residential demand side management architecture, approaches, optimization models and methods. *Renew. Sustain. Energy Rev.* 59, 342–351.
- Fang, M., Wan, J., Xu, X., Wu, G., 2008. System for temperature monitor in substation with ZigBee connectivity, in: 2008 11th IEEE International Conference on Communication Technology. IEEE, pp. 25–28.
- Friedman, J., Hastie, T., Tibshirani, R., 2010. Regularization paths for generalized linear models via coordinate descent. *J. Stat. Softw.* 33, 1.
- Gatsis, N., Giannakis, G.B., 2012. Residential load control: Distributed scheduling and convergence with lost AMI messages. *IEEE Trans. Smart Grid* 3, 770–786.
- Harper, R., 2011. *The connected home: The future of domestic life*. Springer.
- Harper, R., 2006. *Inside the smart home*. Springer Science & Business Media.
- Harper, R., 2003. Inside the smart home: Ideas, possibilities and methods, in: *Inside the Smart Home*. Springer, pp. 1–13.
- Hart, D.G., 2008. Using AMI to realize the Smart Grid, in: 2008 IEEE Power and Energy Society General Meeting-Conversion and Delivery of Electrical Energy in the 21st Century.

- Herter, K., 2007. Residential implementation of critical-peak pricing of electricity. *Energy Policy* 35, 2121–2130.
- Hong, J., 2009. The development, implementation, and application of Demand Side Management and control (DSM+ c) algorithm for integrating micro-generation system within built environment. University of Strathclyde.
- Huang, S., Xiao, J., Pekny, J.F., Reklaitis, G.V., Liu, A.L., 2011. Quantifying system-level benefits from distributed solar and energy storage. *J. Energy Eng.* 138, 33–42.
- Ikegami, T., Iwafune, Y., Ogimoto, K., 2010. Optimum Operation Scheduling Model of Domestic Electric Appliances for Balancing Power Supply and Demand, in: *Power System Technology (POWERCON), 2010 International Conference On.* IEEE, pp. 1–8.
- ImranKhan, V.T., Saleem, A.S., 2015. THE SMART GRID TECHNOLOGY FOR OPTIMAL AND DISTRIBUTED DEMAND RESPONSE STRATEGY WITH ELECTRIC VEHICLE.
- Jason Palmer, Nicola Terry, Tom Kane, 2013. *Early Findings: Demand side management.* Camb. Archit. Res. Ltd.
- Jiang, L., Liu, D.-Y., Yang, B., others, 2004. Smart home research, in: *Proceedings of the Third Conference on Machine Learning and Cybernetics SHANGHAI.* pp. 659–664.

- Khadgi, P., Bai, L., Evans, G., Zheng, Q.P., 2015. A simulation model with multi-attribute utility functions for energy consumption scheduling in a smart grid. *Energy Syst.* 6, 533–550.
- Khan, A.A., Razzaq, S., Khan, A., Khursheed, F., others, 2015. HEMSs and enabled demand response in electricity market: an overview. *Renew. Sustain. Energy Rev.* 42, 773–785.
- Khatib, H., 2003. Economic evaluation of projects in the electricity supply industry. IET.
- Kushwaha, N., Kim, M., Kim, D.Y., Cho, W.-D., 2004. An intelligent agent for ubiquitous computing environments: smart home UT-AGENT, in: *Software Technologies for Future Embedded and Ubiquitous Systems*, 2004. Proceedings. Second IEEE Workshop On. IEEE, pp. 157–159.
- Leismann, K., Schmitt, M., Rohn, H., Baedeker, C., 2013. Collaborative consumption: towards a resource-saving consumption culture. *Resources* 2, 184–203.
- LG&E, 2015. Rate, Terms and Conditions for Furnishing Electric Service.: Louisville gas and electric company.
- Liu, Y., Yuen, C., Huang, S., Ul Hassan, N., Wang, X., Xie, S., 2014. Peak-to-Average Ratio Constrained Demand-Side Management With Consumer's Preference in Residential Smart Grid. *Sel. Top. Signal Process. IEEE J. Of* 8, 1084–1097.

- Lundén, J., Werner, S., Koivunen, V., 2013. Distributed demand-side optimization with load uncertainty, in: Acoustics, Speech and Signal Processing (ICASSP), 2013 IEEE International Conference On. IEEE, pp. 5229–5232.
- Mamounakis, I., Efthymiopoulos, N., Tsaousoglou, G., Vergados, D.J., Makris, P., Varvarigos, E., 2018. A novel pricing scheme for virtual communities towards energy Efficiency, in: 2018 IEEE International Energy Conference (ENERGYCON). IEEE, pp. 1–6.
- Manasseh, E., Ohno, S., Kalegele, K., Tariq, R., 2015. Demand Side Management to Minimize Peak-to-Average Ratio in Smart Grid, in: Proceedings of the ISCIE International Symposium on Stochastic Systems Theory and Its Applications. システム制御情報学会ストカスティックシステムシンポジウム, pp. 102–107.
- Marzband, M., Sumper, A., Domínguez-García, J.L., Gumara-Ferret, R., 2013. Experimental validation of a real time energy management system for microgrids in islanded mode using a local day-ahead electricity market and MINLP. *Energy Convers. Manag.* 76, 314–322.
- McDonald, J., 2008. Leader or follower [The Business Scene]. *IEEE Power Energy Mag.* 6, 18–90. <https://doi.org/10.1109/MPE.2008.929699>
- Md Diah, J., Ahmad, J., 2012. The Methodology on Statistical Analysis of Data Transform...
- Google Scholar [WWW Document]. URL <https://scholar-google->

nl.plymouth.idm.oclc.org/scholar?hl=nl&as_sdt=0%2C5&q=The+Methodology+on
+Statistical+Analysis+of+Data+Transformation+for+Model+Development&btnG=
(accessed 11.8.18).

Meyabadi, A.F., Deihimi, M.H., 2017. A review of demand-side management: reconsidering theoretical framework. *Renew. Sustain. Energy Rev.* 80, 367–379.

Mohsenian-Rad, A.-H., Leon-Garcia, A., 2010. Optimal residential load control with price prediction in real-time electricity pricing environments. *Smart Grid IEEE Trans. On* 1, 120–133.

Mohsenian-Rad, A.-H., Wong, V.W., Jatskevich, J., Schober, R., 2010a. Optimal and autonomous incentive-based energy consumption scheduling algorithm for smart grid, in: *Innovative Smart Grid Technologies (ISGT)*, 2010. IEEE, pp. 1–6.

Mohsenian-Rad, A.-H., Wong, V.W., Jatskevich, J., Schober, R., Leon-Garcia, A., 2010b. Autonomous demand-side management based on game-theoretic energy consumption scheduling for the future smart grid. *Smart Grid IEEE Trans. On* 1, 320–331.

Morgenthaler, G.W., Glover, F.W., Woodcock, G.R., Laguna, M., 2005. APPLICATION OF A BIP CONSTRAINED OPTIMIZATION MODEL COMBINED WITH NASA'S ATLAS MODEL TO OPTIMIZE THE SOCIETAL BENEFITS OF THE

USA's INTERNATIONAL SPACE EXPLORATION AND UTILIZATION
INITIATIVE OF 1/14/04.

- Mullaly, C., 1998. Home energy use behaviour: a necessary component of successful local government home energy conservation (LGHEC) programs. *Energy Policy* 26, 1041–1052.
- NECG, 2014. NECG #3 - nuclear base load | Nuclear Economics. Nucl. Econ. Consult. Group. URL <http://nuclear-economics.com/nuclear-base-load/> (accessed 6.29.16).
- Nguyen, H.K., Song, J.B., Han, Z., 2012. Demand side management to reduce peak-to-average ratio using game theory in smart grid, in: *Computer Communications Workshops (INFOCOM WKSHPS), 2012 IEEE Conference On. IEEE*, pp. 91–96.
- Paatero, J.V., Lund, P.D., 2006. A model for generating household electricity load profiles. *Int. J. Energy Res.* 30, 273–290.
- Palmborg, C., 1986. Social habits and energy consumption in single-family homes. *Energy* 11, 643–650.
- Parisio, A., Glielmo, L., 2011. A mixed integer linear formulation for microgrid economic scheduling, in: *Smart Grid Communications (SmartGridComm), 2011 IEEE International Conference On. IEEE*, pp. 505–510.

- Pedrasa, M.A.A., Spooner, T.D., MacGill, I.F., 2010. Coordinated scheduling of residential distributed energy resources to optimize smart home energy services. *IEEE Trans. Smart Grid* 1, 134–143.
- Pérez-Lombard, L., Ortiz, J., Pout, C., 2008. A review on buildings energy consumption information. *Energy Build.* 40, 394–398.
- Rasheed, M.B., Javaid, N., Ahmad, A., Khan, Z.A., Qasim, U., Alrajeh, N., 2015. An efficient power scheduling scheme for residential load management in smart homes. *Appl. Sci.* 5, 1134–1163.
- Rastegar, M., Fotuhi-Firuzabad, M., Aminifar, F., 2012. Load commitment in a smart home. *Appl. Energy* 96, 45–54.
- Rehmani, M.H., Rachedi, A., Erol-Kantarci, M., Radenkovic, M., Reisslein, M., 2016. Cognitive radio based smart grid: The future of the traditional electrical grid. *Ad Hoc Netw.* 1–4.
- Ricquebourg, V., Menga, D., Durand, D., Marhic, B., Delahoche, L., Loge, C., 2006. The smart home concept: our immediate future, in: 2006 1st IEEE International Conference on E-Learning in Industrial Electronics. IEEE, pp. 23–28.
- Rinkinen, J., Shove, E., Torriti, J., 2019. *Energy Fables: Challenging Ideas in the Energy Sector*. Routledge.

- Ross, D.F., 2015. *Distribution Planning and control: managing in the era of supply chain management*. Springer.
- Saad Al-Sumaiti, A., Ahmed, M.H., Salama, M.M., 2014. Smart home activities: A literature review. *Electr. Power Compon. Syst.* 42, 294–305.
- Saffari, M., de Gracia, A., Fernández, C., Belusko, M., Boer, D., Cabeza, L.F., 2018. Optimized demand side management (DSM) of peak electricity demand by coupling low temperature thermal energy storage (TES) and solar PV. *Appl. Energy* 211, 604–616.
- Samadi, P., Mohsenian-Rad, H., Schober, R., Wong, V.W., 2012. Advanced demand side management for the future smart grid using mechanism design. *IEEE Trans. Smart Grid* 3, 1170–1180.
- Setlhaolo, D., Xia, X., 2016. Combined residential demand side management strategies with coordination and economic analysis. *Int. J. Electr. Power Energy Syst.* 79, 150–160.
- Setlhaolo, D., Xia, X., 2015. Optimal scheduling of household appliances with a battery storage system and coordination. *Energy Build.* 94, 61–70.
- Shin, J.-S., Bae, I.-S., Kim, J., 2017. Impact of User Convenience on Appliance Scheduling of a Home Energy Management System. *Korean Inst. Electr. Eng.*

- Soares, A., Gomes, Á., Antunes, C.H., 2014. Categorization of residential electricity consumption as a basis for the assessment of the impacts of demand response actions. *Renew. Sustain. Energy Rev.* 30, 490–503.
- Sou, K.C., Weimer, J., Sandberg, H., Karl Henrik, J., 2011. Scheduling smart home appliances using mixed integer linear programming, in: 50th IEEE Conference on Decision and Control and European Control Conference. IEEE.
- Steinheimer, M., Trick, U., Fuhrmann, W., Ghita, B., 2013. Load reduction in distribution networks through P2P networked energy-community, in: Proc. of Fifth International Conference on Internet Technologies & Applications (ITA 13).
- Steinheimer, M., Trick, U., Ghita, B., Fuhrmann, W., 2015. P2P based service provisioning in M2M networks, in: Internet Technologies and Applications (ITA), 2015. IEEE, pp. 132–137.
- Teubner, T., Adam, M.T., Camacho, S., Hassanein, K., 2014. Understanding resource sharing in C2C platforms: the role of picture humanization. *ACIS*.
- Troy, N., Denny, E., O'Malley, M., 2008. The relationship between base-load generation, start-up costs and generation cycling, in: Paper Presented at the 28th USAEE/IAEE North American Conference" Unveiling the Future of Energy Frontiers", New Orleans, December 3-5 2008. International Association for Energy Economics.

- Tsui, K.M., Chan, S.-C., 2012. Demand response optimization for smart home scheduling under real-time pricing. *IEEE Trans. Smart Grid* 3, 1812–1821.
- Tushar, M.H.K., Assi, C., Maier, M., Uddin, M.F., 2014. Smart microgrids: Optimal joint scheduling for electric vehicles and home appliances. *IEEE Trans. Smart Grid* 5, 239–250.
- Ullah, I., Khitab, Z., Khan, M.N., Hussain, S., 2019. An efficient energy management in office using bio-inspired energy optimization algorithms. *Processes* 7, 142.
- Wolak, F.A., 2003. Diagnosing the California electricity crisis. *Electr. J.* 16, 11–37.
- Wong, J., 2007. Automatic planning and optimisation of in-building CDMA systems (PhD Thesis). ResearchSpace@ Auckland.
- Wood, G., Newborough, M., 2003. Dynamic energy-consumption indicators for domestic appliances: environment, behaviour and design. *Energy Build.* 35, 821–841.
- Wright, D.B., London, K., 2009. *First (and second) steps in statistics*. Sage Publications.
- Wright, S.J., 2015. Coordinate descent algorithms. *Math. Program.* 151, 3–34.
- Yahia, Z., Kholopane, P., 2018. A binary integer programming model for optimal load scheduling of household appliances with consumer's preferences, in: 2018 International Conference on the Domestic Use of Energy (DUE). IEEE, pp. 1–8.
- Yahia, Z., Pradhan, A., 2018. Optimal load scheduling of household appliances considering consumer preferences: An experimental analysis. *Energy* 163, 15–26.

- Yang, P., Tang, G., Nehorai, A., 2013. A game-theoretic approach for optimal time-of-use electricity pricing. *Power Syst. IEEE Trans. On* 28, 884–892.
- Yaseen, Y., Ghita, B., 2019. Willingness Impact to the PAR Optimisation of R-users Community using EMS. *Energy Procedia* 156, 315–320.
- Yaseen, Y., Ghita, B., 2017. Peak-to-Average Reduction by Community-Based DSM. 2017 5th IEEE Int. Conf. Smart Energy Grid Eng.
- Yohanis, Y.G., Mondol, J.D., Wright, A., Norton, B., 2008. Real-life energy use in the UK: How occupancy and dwelling characteristics affect domestic electricity use. *Energy Build.* 40, 1053–1059.
- Zhang, Y., Patwa, F., Sandhu, R., 2015. Community-based secure information and resource sharing in aws public cloud, in: *Collaboration and Internet Computing (CIC), 2015 IEEE Conference On.* IEEE, pp. 46–53.
- Zhu, Z., Tang, J., Lambotharan, S., Chin, W.H., Fan, Z., 2011. An integer linear programming and game theory based optimization for demand-side management in smart grid, in: *GLOBECOM Workshops (GC Wkshps), 2011 IEEE.* IEEE, pp. 1205–1210.
- Zunnurain, I., Maruf, M., Rahman, M., Shafiullah, G.M., 2018. Implementation of advanced demand side management for microgrid incorporating demand response and home energy management system. *Infrastructures* 3, 50.